



CODONICS[®]

We bring the future into focus

Safe Label System[®]
SLS 600i
Point of Care Station

User's Manual

Codonics[®] Catalog Number SLS600-MNLU-3.0.0

April 26, 2023

Version 3.0.0 - 042623

Codonics, Inc.

17991 Englewood Drive

Middleburg Heights, OH 44130 USA

440.243.1198 Phone

440.243.1334 Fax

Email info@codonics.com

www.codonics.com

Copyright © 2010 – 2023 by Codonics, Inc. All rights reserved, worldwide. Printed in the USA Part Number 905-112-104.

No part of this document may be copied or reproduced in any form by any means without prior written consent of Codonics, Inc., 17991 Englewood Dr., Middleburg Heights, Ohio 44130 USA.

Although every effort has been made to ensure the accuracy of this document, Codonics, Inc. assumes no responsibility for any errors that may appear. Codonics, Inc. makes no commitment to update nor to keep current the information contained in this document.

Patents: www.codonics.com/ip/patents.

Codonics, the Codonics logo, “We bring the future into focus” and Safe Label System are registered trademarks of Codonics, Inc.

Sani-Cloth is a registered trademark of Professional Disposables International, Inc. Windows is a registered trademark of Microsoft Corporation in the United States and/or other countries. iPad is a registered trademark of Apple Inc., registered in the U.S. and other countries. All other registered and unregistered trademarks are the property of their respective owners.



CAUTION Federal law restricts this device to be sold for use by or on the order of a physician.

European Authorized Representative:



CEpartner4U
Esdoornlaan 13,
3951DB Maarn
The Netherlands
www.cepartner4u.com

Contents

Preface

Conventions Used in This Manual.....	xiii
Bulleted Lists.....	xiii
Numbered Steps.....	xiii
Notes.....	xiv
Cautions and Warnings.....	xiv
Important Information and Filenames.....	xiv
Purpose and Scope.....	xv
Product Information.....	xvi
Warnings and Limitations of Use.....	xvii
Location of Safety and Compliance Labels.....	xvii
Voltage Warning.....	xviii
Dangers électriques.....	xix
Laser Warning.....	xx
Danger du Faisceau Laser.....	xx
Serial Number, Configuration, Date Code, and Modification Codes.....	xxi
Potential for Radio Frequency Interference on Device Operation.....	xxii
Potential for Radio and Television Interference.....	xxii
Potential for Operator Exposure to Radio Frequency Energy.....	xxiii
Potentiel d'Exposition de l'Opérateur à l'Énergie des Radiofréquences.....	xxiii
Guidance Regarding Electromagnetic Emissions and Immunity.....	xxiv
Electromagnetic Emissions Standards and Test Levels.....	xxvi
Electromagnetic Immunity Standards and Test Levels.....	xxvi
Safety Precautions.....	xxviii
Précaution d'Emploi.....	xxix

Location Precautions.....	xxx
Environnement de Fonctionnement	xxxix
Cleaning Precautions	xxxix
Précautions d'Entretien	xxxix
Disinfecting Precautions.....	xxxix
Précautions de Désinfection	xxxix
Media Precautions	xxxix
Précautions de Média et Consommables	xxxix
Disposal Requirements	xxxix
Conditions et Règles d'Utilisation.....	xxxix
European Disposal Requirements	xxxix
Indications for Use.....	xxxix
Device Description	xxxix
Device Characteristics	xxxix
Device Indications for Use Statement: Prescription Use Device.....	xxxix

Chapter 1: Introduction

Welcome and Congratulations	1-1
Product Features	1-2
Hardware Features	1-2
Operational Features	1-3

Chapter 2: Setting Up the System

Finding a Location for the System	2-1
Shipped Components	2-2
Identifying the Components.....	2-5
SLS PCS Front Components	2-5

Components Inside SLS PCS Front Cover	2-7
SLS PCS Rear Components	2-9
SLS PCS Wi-Fi Adapter USB Port	2-10
MAC Address Label Locations	2-11
Touch Screen	2-12
Connecting the Ethernet Cable (Optional)	2-13
Connecting the Wi-Fi Adapter (Optional)	2-15
Connecting the External Power Supply	2-16
Inserting the SmartDrive	2-18
Starting Up the System	2-19
Installing the Ink Cartridge	2-21
Loading or Replacing the Label Media	2-26
End of Media Roll Behavior	2-30
SmartDrive and Stored Information	2-31
Information Stored on the SmartDrive	2-31
Events That Synchronize Data to the SmartDrive	2-32

Chapter 3: Basic Operations

Making a User Badge	3-1
Logging In	3-3
Touch Screen User Interface	3-11
SLS Utilities	3-12
Displaying the Utilities Screen	3-14
Cleaning the Ink Cartridge Nozzles	3-15
Adjusting the Media Path	3-18
Adjusting the Label Black Levels	3-20
Setting Fast Print Mode	3-22
Printing a User Badge	3-23

Calibrating the Printer	3-25
Configuring the Network.....	3-26
Backing Up Log Files	3-27
Clearing Errors	3-30
Adding a Feature.....	3-32
Setting the Date and Time.....	3-35
Adjusting the Touch Screen Brightness	3-37
Adjusting the Audio Volume	3-37
Closing the Utilities screen.....	3-39
Logging Out	3-40
Being Logged Out Automatically Due to Inactivity	3-41
Screen Saver On Due to Inactivity	3-42
Auto-Logout and Screen Saver in Batch or Copy Mode	3-42
Shutting Down or Restarting the System.....	3-43
Shutting Down or Restarting from the Main Screen	3-43
Shutting Down from the Login Prompt	3-44
Powering Off the System	3-45

Chapter 4: Configuring the Network Connection

Static SLS PCS Device Names	4-2
Setting Up Network Hardware	4-3
Configuring an Ethernet Network Connection	4-3
Configuring an Enterprise Wi-Fi Network Connection	4-9
Configuring a Non-Enterprise Wi-Fi Network Connection	4-21
Disabling the Network Connection	4-32
Network Connection Status	4-35
When Network Connection Settings Are Saved.....	4-37

Chapter 5: Printing Labels

Overview.....	5-1
Formulary Database.....	5-1
Container IDs (Outside the USA).....	5-2
Container IDs and Master IDs (USA Only).....	5-2
Matching Container IDs.....	5-2
Mapping Container IDs to Master IDs (USA Only).....	5-3
Verification.....	5-3
Communication of Verification and Drug Not Found Events to the SLS Administration Tool.....	5-3
SLS Drug Preparation Methods.....	5-4
Notes About TD/TV Preparation Method.....	5-5
Printing a Syringe Label.....	5-6
Scanning the Drug Container Barcode.....	5-7
Selecting from Matching Container IDs.....	5-9
Learning a Drug (USA Only).....	5-10
Verifying a Drug.....	5-12
Drug Not Found (DNF) and Other Item Events.....	5-13
Specifying the Dilution and Diluent (Normal Dilution Method).....	5-16
Specifying a Total Dose/Total Volume and Diluent (TD/TV Method).....	5-19
Confirming the Syringe Label Before Printing It.....	5-34
Confirming the Printed Syringe Label.....	5-36
Auxiliary Barcodes for Container IDs.....	5-38
Printing a Placeholder Graphic for a Non-Compliant Container ID.....	5-39
Manually Entering the Expiration Date/Time on a Syringe Label.....	5-40
Custom Labels.....	5-40
Custom Label Categories.....	5-40
Blank.....	5-41
Lines.....	5-42

IV	5-43
Patient.....	5-44
Printing Custom Labels	5-45
Printing Labels in Batch Mode	5-47
Positioning SLS PCS to Support Printing Labels in Batch Mode	5-48
Printing Multiple Labels in Batch Mode	5-48
Reaching the End of Media Before a Batch or Copy Job Completes	5-54
Strip Cut Printing.....	5-54
Single Cut Printing	5-55
Printing Labels in Copy Mode.....	5-56
SLS Advanced Smart Scanning	5-61
SASS Use Cases	5-61
SLS Formulary Drug Print Setting Set to Always.....	5-62
SLS Formulary Drug Print Setting Set to Never (e.g., Pre-Filled Syringe)	5-63
SLS Formulary Drug Print Setting Set to Allow (e.g., Pre-Filled Syringe)	5-64
Drug Container Not Found in the SLS Formulary	5-65
Drug Container Not Found in the SLS Formulary but Stocked in the Cart (e.g., Gauze, Syringes)	5-66

Chapter 6: Administer Mode

Drug Is Found in the Formulary, Has Not Expired	6-3
Drug Is Found in the Formulary, Has Expired.....	6-3
Drug Is Found in the Formulary, Requires Concentration Confirmation	6-4
Drug Is Not Found in the Formulary	6-5
Unknown Error Occurs	6-6

Chapter 7: Label Sizes and Template Packs

Label Sizes	7-1
Label Template Packs	7-1
STD-1	7-2
STD-2	7-3
STD-3	7-4
Label Template Properties	7-6
User Initials and User IDs in STD-1, STD-2, and EHR-1 Template Labels	7-8
Additional Label Template Packs	7-9
Label Templates That Support Over-Labeling (RBX-1)	7-9
Middle East and Australia Combination Drug Label Template Packs (ME-S1, ME-1)	7-10
China Label Template Packs (ZH-S1, ZH-1)	7-11
Japan Label Template Packs (JP-S1, JP-1)	7-12
EHR Template Pack (EHR-1, EHR-2)	7-13
EBD Template Pack (EBD-3)	7-13

Chapter 8: Third-Party Product Integration

SLS Wired Hand Scanner	8-1
Connecting the Wired Hand Scanner to SLS PCS	8-2
Testing the Wired Hand Scanner Communication with SLS PCS	8-3
Configuring the Codonics-Approved Scanner for SLS PCS	8-4
Cleaning and Disinfecting the Wired Hand Scanner	8-4
Daily Cleaning and Disinfecting Instructions	8-5
Monthly Deep Cleaning and Disinfecting Instructions	8-5
Common Login/Common Scan	8-6
Plexus TG Anesthesia Touch™	8-7
B.Braun Space Pump	8-8

Printing Patient Information on Labels.....	8-9
Starting a New Patient Case	8-11
Labels That Support Patient Information.....	8-12
How Invalid Patient Information Is Handled	8-13

Chapter 9: Maintenance

Ordering Supplies and Parts	9-1
Cleaning the Enclosure	9-2
Cleaning Precautions.....	9-3
Disinfecting the Enclosure	9-4
Disinfecting Precautions.....	9-4
Installing Update Packages	9-5
Manually Installing an Update Package.....	9-6
Remotely Installing Update Packages	9-8
Manually Installing SLS System Software.....	9-9
Removing the Rear Cover	9-12
Swapping Systems	9-13
Preparing the System for Shipping.....	9-13

Chapter 10: Troubleshooting

Status Indicators.....	10-1
Displaying System Information	10-2
Status Tab.....	10-3
Printer Tab	10-4
User Tab	10-5
Network Tab.....	10-6
System Tab.....	10-7

System Status Messages	10-8
Troubleshooting Common Problems	10-10
Clearing a Label Media Jam	10-24
Clearing a Label Jam in the Front Media Guide.....	10-24
Clearing a Label Jam in the Rear Media Guide	10-26

Appendix A: Hazardous Material Information

Materials of Construction	A-1
Matériaux de Construction	A-2
Manufacturing	A-3
Fabrication	A-3

Appendix B: Specifications

Specifications (English)	B-1
Specifications (French).....	B-3

Preface

Conventions Used in This Manual

Bulleted Lists

Bullets are used to display a list of nonprocedural items. For example:

The following events trigger a synchronization of SLS data to that stored on the SmartDrive:

- Automatically every 15 minutes
- Formulary updates

Numbered Steps

The  icon indicates the beginning of a procedure. The steps in a procedure are numbered. For example:



To install an
ink cartridge

1. Open the front cover.
2. Press the Ink button.

Notes

Notes contain additional information related to a topic or procedure. For example:



NOTE: The system will ensure that a test print is performed at least once a day.

Cautions and Warnings

Cautions alert you to actions or situations that could cause harm to equipment or data. For example:



CAUTION Do not touch the copper area of the cartridge print head.

Warnings alert you to actions or situations that could result in personal injury. For example:



WARNING When the front cover is open, avoid contact with the label cutter.

Important Information and Filenames

Bold type is used for emphasis, user interface object names, and paths or filenames. For example:

- The **Barcode Scanner** scans drug container barcodes for identity and verification.
- Use the controls to correct the date and time, then press the **OK** button.

Purpose and Scope

Refer to this User's Manual for procedures on how to perform Safe Label System (SLS) user operations, including:

- Setting up the hardware and software
- Performing basic functions such as logging in and out, and configuring some system settings (for example, sound volume, brightness)
- Printing and confirming syringe labels
- Checking drug syringes by scanning their barcodes
- Maintaining the system
- Monitoring system status and troubleshooting common problems

Product Information

For technical assistance with SLS Point of Care Station (PCS), call Codonics Technical Support at the following number:

Phone: +1 440.243.1198
Toll Free: 800.444.1198 (USA only)

Technical Support is available 24/7/365. Technical Support is also available online via email and the Codonics web site:

Email: support@codonics.com
Web Sites: www.codonics.com

General product information can also be requested by sending email to:

Email: info@codonics.com

Please include your postal mailing address and telephone number in the email message. Basic product information is returned via email unless otherwise requested.

Warnings and Limitations of Use

Location of Safety and Compliance Labels

Codonics is in compliance with various regulations, details of which are listed in Appendix B.

The SLS PCS safety and compliance label, shown below, is located on the bottom of the device (shown on the following page).

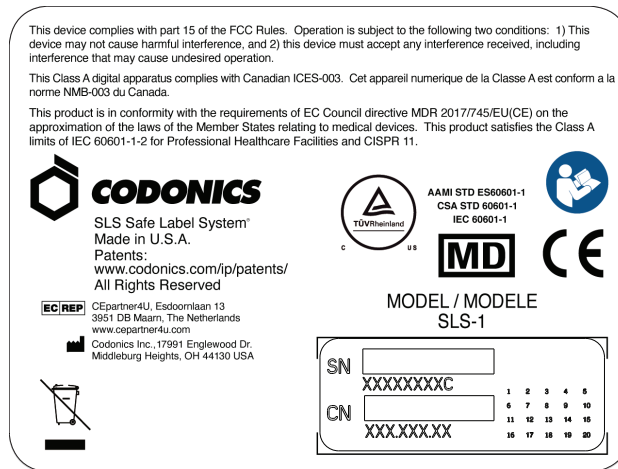

SLS PCS safety and compliance label

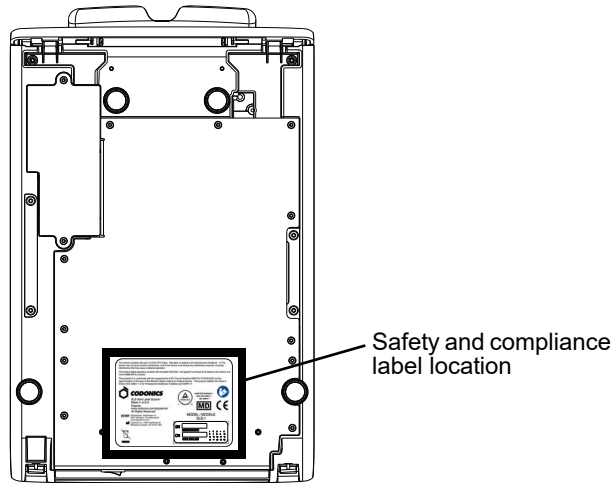

SLS PCS safety and compliance label, on bottom of device

Voltage Warning

The exclamation point within a triangle is intended to alert the user to the presence of important operating and maintenance (servicing) instructions in the literature accompanying this device.



REFER SERVICING TO QUALIFIED SERVICE PERSONNEL. REMOVAL OF LABELS, COVERS, OR ENCASMENT FASTENERS MAY VOID THE WARRANTY.

THIS APPARATUS MUST BE ELECTRICALLY GROUNDED.

TO PREVENT FIRE OR SHOCK HAZARD, DO NOT EXPOSE THIS DEVICE TO RAIN OR MOISTURE.

EQUIPMENT IS NOT TO BE USED AS A COMPONENT OF A LIFE SUPPORT SYSTEM. Life support devices or systems are devices or systems that support or sustain life, and whose failure to perform can be reasonably expected to result in a significant injury or death to a person. A critical component is any component of a life support device or system whose failure to perform can be reasonably expected to cause the failure of the life support device or system, or to affect its safety or effectiveness.



WARNING Grounding reliability can be achieved only when SLS PCS is connected to a receptacle marked “Hospital Only” (that is, “Hospital Grade”).



WARNING The power cord connected to SLS PCS is the main disconnect for the system.



WARNING To disconnect overall power to SLS PCS prior to servicing it, power off the system (refer to “Powering Off the System” on page 3-45).

Dangers Électriques

Le point d'exclamation situé à l'intérieur d'un triangle représente un point d'instruction important dans l'utilisation ou l'entretien de cette appareil.



POUR SOUTIEN ADRESSEZ-VOUS AU PERSONNEL QUALIFIE. LE RETRAIT DE LES ETIQUETTES, LES COUVERTURES, OU LES ATTACHES PEUT ANNULENT LA GARANTIE. CET APPAREIL DOIT ETRE ELECTRIQUEMENT RELIE A LA TERRE.

N'EXPOSEZ PAS CET APPAREIL À LA PLUIE OU L'HUMIDITÉ, EN RAISON DU RISQUE DE FEU OU DE DÉCHARGES ÉLECTRIQUES.

Cet appareil ne doit pas être utilisé comme composant d'un système d'assistance vitale. Les devis ou les systèmes vitale sont quelque devis ou système qui assistent ou soutiennent la vie, et si les devis ou systèmes échouent, on peut attend raisonnablement la mort ou la blessure. Cet appareil ne doit pas être utilisé dans des conditions où la défaillance de l'appareil pourrait entraîner la blessure ou la mort de quelqu'un.



ATTENTION Une mise à la terre fiable est possible seulement pendant que le SLS PCS est connecté aux appareils marqué "Hospital Only" (de qualité hospitalière).



ATTENTION Le fil électrique connecté à le SLS PCS sont le système de coupure principal de l'appareil.



ATTENTION Pour débrancher le fil électrique avant le soutien, se déconnecter et puis éteint le système (renvoyer à « Powering Off the System » sur la page 3-45).

Laser Warning



WARNING This device emits CDRH/IEC Class 2 laser and IEC Class 1M light. Do not stare into beam.

Danger du Faisceau Laser



ATTENTION Cet appareil émet un laser CDRH / CEI de classe 2 et une lumière de classe 1M IEC. Ne pas fixer le faisceau.

Serial Number, Configuration, Date Code, and Modification Codes

The serial number label is placed onto the safety and compliance label.

The serial number label includes the following information:

- The serial number (SN), which uniquely identifies the unit.
- The configuration number (CN), which details the build configuration.
- The modifications codes, which are to the right of the CN number and are a series of 20 numbers. When any of these numbers are blocked out, that identifies a modification that was made to the unit.

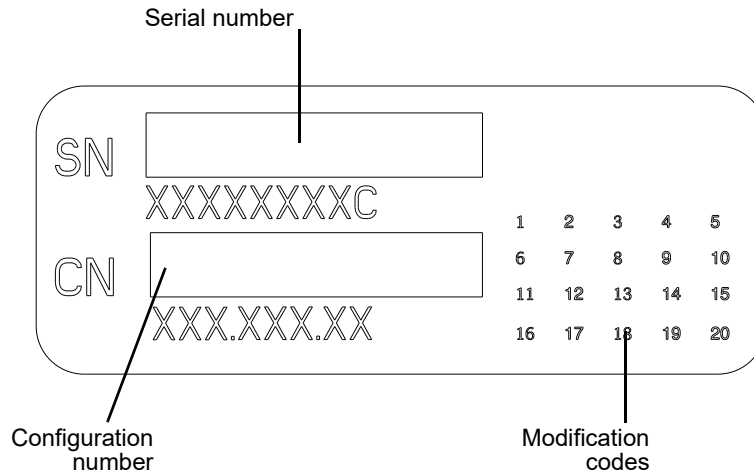

Serial number label

Potential for Radio Frequency Interference on Device Operation

Both portable and mobile RF communications equipment can affect medical electrical equipment, including SLS PCS. SLS PCS is intended for use in the electromagnetic environment specified in the guidance and manufacturer's declaration section.

Potential for Radio and Television Interference

SLS PCS generates and uses radio frequency energy, and if not installed and used properly, that is, in strict accordance with the manufacturer's instructions, may cause interference to radio and television reception. This device complies with part 15 of the FCC Rules. Operation is subject to the following two conditions: (1) This device may not cause harmful interference, and (2) this device must accept any interference received, including interference that may cause undesired operation. SLS PCS is not intended for use in a residential Class A environment. SLS PCS requires a medical power/ground. If your SLS does cause interference to radio or television reception, you are encouraged to try to correct the interference by one or more of the following measures:

- Reorient the receiving antenna
- Relocate SLS PCS with respect to the receiver

If necessary, you should consult Codonics Technical Support or an experienced radio/television technician for additional suggestions. You may find the following booklet prepared by the Federal Communications Commission helpful: *How to Identify and Resolve Radio-TV Interference Problems*. This booklet is available from the U.S. Government Printing Office, Washington, D.C. 20402, Stock No. 004-000-00345-4.

Le présent appareil numérique n'émet pas de bruits radio-électriques dépassant les limites applicables aux appareils numériques de la Classe B prescrites dans le Règlement sur le brouillage radioélectrique édicté par le ministère des Communications du Canada.

This product is in conformity with the protection requirements of EC Council directive MDR 2017/745/EU(CE) on the approximation of the laws of the Member States relating to medical devices. This product satisfies the Class A limits of IEC 60601-1-2 for Professional Healthcare Facilities and CISPR 11. A declaration of conformity with the requirements of the Directive has been signed by a Codonics vice president.

Potential for Operator Exposure to Radio Frequency Energy

The Safe Label System, when equipped, emits radio frequency energy for the purpose of reading and writing to radio frequency identification (RFID) tags. The device transmits momentarily after scanning a drug barcode at the front cover and also when printing labels equipped with RFID functionality. The radio transmitters are disabled at all other times. The Safe Label System meets the radio frequency exposure requirements of the U.S. 47CFR 1.1310 and Canada RSS-102 standards. The time-averaged power of emitted radio energy is well below the SAR exemption thresholds for human exposure set forth by the United States and Canada.

Potentiel d'Exposition de l'Opérateur à l'Énergie des Radiofréquences

Le Safe Label System, lorsqu'il est équipé, émet de l'énergie radiofréquence dans le but de lire et d'écrire sur des étiquettes d'identification par radiofréquence (RFID). L'appareil transmet momentanément après avoir scanné un code-barres de médicament sur l'étiquette avant et également lors de l'impression d'étiquettes équipées de la fonctionnalité RFID. Les émetteurs radio sont désactivés à tout autre moment. Le Safe Label System répond aux exigences d'exposition aux radiofréquences des normes U.S. 47CFR 1.1310 et Canada RSS-102. La puissance moyenne dans le temps de l'énergie radio émise est bien inférieure aux seuils d'exemption SAR pour l'exposition humaine établis par les États-Unis et le Canada.

Guidance Regarding Electromagnetic Emissions and Immunity

Suitable environments are as follows:

- SLS600i is intended for use in hospital and clinical environments including operating rooms and the perioperative environment.
- SLS600i has not been evaluated for use near HF surgical equipment. If use near HF surgical equipment is desired, the user is responsible for verifying proper operation of the SLS600i. If SLS600i does not perform correctly in this environment, move the SLS600i farther from the source of the electromagnetic disturbance.
- SLS600i has not been evaluated for use in emergency medical vehicles or in residential applications.



NOTE: *The radio frequency emissions characteristics of this equipment make it suitable for use in industrial areas and hospitals (CISPR 11 class A). If it is used in a residential environment (for which CISPR 11 class B is normally required) this equipment might not offer adequate protection to radio-frequency communication services. The user might need to take mitigation measures, such as relocating or re-orienting the equipment.*

As a support device, SLS600i does not provide essential performance.



WARNING Use of this equipment adjacent to or stacked with other equipment should be avoided because it could result in improper operation. If such use is necessary, this equipment and the other equipment should be observed to verify that they are operating normally.



WARNING Use of accessories, transducers and cables other than those specified or provided by the manufacturer of this equipment could result in increased electromagnetic emissions or decreased electromagnetic immunity of this equipment and result in improper operation.



WARNING Portable RF communications equipment (including peripherals such as antenna cables and external antennas) should be used no closer than 30 cm (12 inches) to any part of the SLS600i, its cables, or accessories. Otherwise, degradation of the performance of this equipment could result.



ATTENTION The Safe Label System contains authorized radio equipment that has been tested and approved as a system. Changes or modifications to the Safe Label System that are not expressly approved by Codonics could void the user's authority to operate this equipment in the field.

Electromagnetic Emissions Standards and Test Levels

Test/Standard	Compliance
RF Emissions CISPR 11	Group 1. Class A
RF Emissions FCC Part 15	Class A
Conducted Emissions CISPR 11	Group 1. Class A
Harmonic Distortion IEC 61000-3-2	Class A
Voltage Fluctuations and Flicker IEC 61000-3-3	Complies

Electromagnetic Immunity Standards and Test Levels

Test/Standard	Compliance
Electrostatic Discharge IEC 61000-4-2	+8 kV contact +2 kV, +4 kV, +8 kV, +-15 kV air
Radiated RF Immunity IEC 61000-4-3	3 V/m 80 MHz – 2.7 GHz 80% AM at 1 kHz
Proximity fields from RF wireless equipment IEC 61000-4-3	Complies

Test/Standard	Compliance
Electrical Fast Transient/Burst	AC Port: ± 2 kV, 100 kHz repetition frequency
IEC 61000-4-4	SIP/SOP Ports: ± 1 kV, 100 kHz repetition frequency
Surge	Line-to-Line: ± 0.5 kV, ± 1.0 kV
IEC 61000-4-5	Line-to-Ground: ± 0.5 kV, ± 1.0 kV, ± 2.0 kV
Conducted Immunity	AC Port and SIP/SOPs:
IEC 61000-4-6	3 V, 0.15 MHz – 80 MHz
	6 V, in ISM bands between 0.15 MHz and 80 MHz
	80% AM at 1 kHz
Magnetic Field Immunity	30 A/m, 50 Hz or 60 Hz
IEC 61000-4-8	
Voltage Dips	0% <i>UT</i> , 0.5 cycle at 0°, 45°, 90°, 135°, 180°, 225°, 270° and 315°
IEC 61000-4-11	0% <i>UT</i> , 1 cycle AND 70% <i>UT</i> , 25/30 cycles, Single phase: at 0°
Voltage Interruptions	0% <i>UT</i> , 250/300 cycle
IEC 61000-4-11	
Radiated fields in close proximity	134.2 kHz: 2.1-kHz pulse modulation, 65 A/m
	13.56 MHz: 50-kHz pulse modulation, 7.5 A/m
IEC 61000-4-39	
Exposure to Radio Frequency ID Readers	Table 3 test levels
AIM 7351731	

Safety Precautions

- Never connect the device's external power supply to any outlet or power supply that has a voltage or frequency different than that specified (100 – 240 VAC, 50/60 Hz).
- Use only the external power supply provided with the device (Codonics part number SLS-PS).
- When replacing the device, always power it down (refer to “Powering Off the System” on page 3-45) and disconnect the AC power cord prior to servicing it.
- Damage to a power cord is a fire and shock hazard. When unplugging a power cord, hold it by the plug only and remove the plug carefully.
- If a power cord or external power supply needs to be replaced, replace it only with another Codonics power cord or Codonics external power supply. Alternatively, replace it with a power cord or external power supply manufactured specifically for your power configuration.
- If the device is smoking or making unusual sounds, power off and unplug the device immediately.
- Do not insert foreign objects of any kind into the device; doing so can constitute a safety hazard and cause extensive damage.
- Do not place any liquid containers on the device. If, for some reason, liquid seeps into the device, power off the device and unplug the power cord from the source outlet. If used without taking corrective measures, the device may be damaged.
- Do not expose the device to flammable gases in concentrations high enough to cause fire or explosion.

Précaution d'Emploi

- *Ne jamais brancher cet appareil sur une source d'alimentation électrique dont la tension ou la fréquence diffèrent des valeurs indiquées (100 – 240 VAC, 50/60 Hz).*
- *Utiliser uniquement l'alimentation électrique fourni avec l'appareil (numero de pièce Codonics SLS-PS).*
- *Avant de remplacer le appareil, veuillez à toujours éteindre l'appareil et n'oubliez pas de débrancher le câble secteur.*
- *Un fil électrique endommagé est une cause d'incendie ou de décharge électrique. En déconnectant le fil électrique, tenez-le seulement par la prise et retirez la prise soigneusement.*
- *Si le fil électrique ou l'alimentation électrique doit être remplacé, utilisez un fil électrique ou un alimentation électrique Codonics fabriqué spécifiquement pour votre appareil.*
- *Si l'appareil fume ou émet des bruits inhabituels arrêtez-le immédiatement et débranchez le fil électrique.*
- *N'introduisez aucun objet étranger dans l'appareil, cela peut être une source de danger et peut causer de graves dommages.*
- *Ne déposez aucun récipient à coté de l'appareil. Si pour quelque raison un liquide filtre à l'intérieur, arrêtez immédiatement l'appareil et débranchez le fil électrique. Toute nouvelle utilisation de l'appareil sans intervention peut causer de graves dommages.*
- *Ne pas utiliser l'appareil à coté d'une source de gaz inflammable.*

Location Precautions

- The operating ambient temperature range of SLS PCS is 15–30°C (59–86°F), with a relative humidity of 20%–80%.
- If SLS PCS is moved quickly from an extremely cold location to a warmer one, condensation is likely to form. Do not use SLS PCS if condensation has formed. Wait until the condensation has evaporated. You can speed up the evaporation time by moving SLS PCS to a dryer location.
- Do not place SLS PCS in a location with high humidity or high dust. Airborne dirt particles can cause print quality problems. Avoid placing SLS PCS in locations where ventilation ducts, open doors, or frequent passers-by might expose SLS PCS and labels to high levels of debris.
- Do not locate SLS PCS in hot-springs areas where hydrogen sulfide and acidic ions are likely to be generated.
- Do not locate SLS PCS where there are oily fumes and vapors.
- Do not locate SLS PCS in direct sunlight.
- Do not locate SLS PCS near sources of high RF energy.
- Do not locate SLS PCS where it might be subject to jarring or vibrations, such as a table or desk in a high-traffic area. Jarring and vibrations can affect the print quality of labels.
- If using a VESA mount to mount the device on a wall, stand, or anesthesia supply cart, refer to the VESA Mounting Interface Standard (MIS), available at www.vesa.org, for proper location and installation information.

Environnement de Fonctionnement

- *Les conditions normales d'utilisation de l'appareil sont : une température de 15 à 30°C et une humidité relative de 20 % à 80 %.*
- *En cas de variation rapide de la température, de la condensation peut se former. En ce cas la n'utilisez pas l'appareil, attendez que la condensation se soit évaporée. Vous pouvez accélère cette évaporation en déplaçant l'appareil dans un endroit sec.*
- *Toujours placez l'appareil dans une zone propre et non-humide. Des particules de poussières peuvent causer des dysfonctionnements de la qualité d'imprimante. Évitez de placer l'appareil à proximité d'une bouche de ventilation, d'une porte, ou d'un endroit très fréquenté car cela pourrait exposer l'appareil ainsi que les étiquettes à la poussière.*
- *Ne placez pas l'appareil à proximité d'une source de chaleur ou de substances acides.*
- *Ne placez pas l'appareil dans une endroit où il y a des vapeurs huileuses et grasses.*
- *N'exposez pas l'appareil à la lumière directe du soleil.*
- *Ne placez pas l'appareil près d'une source haute fréquence.*
- *Ne placez pas l'appareil dans un lieu où il pourrait être exposé à des vibrations, car cela peut nuire l'impression des média.*
- *Si vous utilisez un bras de montage VESA pour monter l'appareil sur un mur, une potence ou un charriot d'anesthésie, veuillez vous référer aux instructions de montage VESA (MIS) sur www.vesa.org pour de plus amples informations.*

Cleaning Precautions

To avoid damage to the device, observe the following general precautions for cleaning the device:

- Apply the cleaner to a clean, lint-free cloth first and then clean the device. Liquid applied directly to the device could possibly leak inside the device and cause damage. Use extra caution when cleaning around the vents on the back of the touch screen and speaker.
- Allow the device to completely dry before operating it again.
- Many plastic components are used in SLS PCS construction. Coat flecking and deformation is likely to occur if the device is wiped with chemical dusters, benzene, thinners, insecticides, or other solvents. Rubber and PVC materials left in contact with SLS PCS for extended periods of time will cause damage. Never use petroleum-based solutions or abrasive cleansers.
- Never use abrasive material.
- Always dilute cleaning agents according to the manufacturer's instructions, or use the lowest possible concentration.
- Do not allow the cleaning agent to remain on the device surfaces. Wipe it off immediately with a lint-free cloth moistened with water.

For cleaning instructions, refer to “Cleaning the Enclosure” on page 9-2.

Précautions d'Entretien

- *Pour éviter les dommages à l'appareil, regardez les précautions d'entretien:*
- *Appliquez le nettoyeur sur un tissu propre et puis nettoyez l'appareil. Liquide qui est appliqué directement sur le appareil peut causer les dommages. Utilisez beaucoup de précautions sur le conduit d'aération en bas de la écran et l'haut-parleur.*
- *L'appareil doit sécher complètement avant marcher encore.*
- *Il y a beaucoup des choses plastiques utilisant avec la fabrication du SLS PCS. L'emploi des chiffons chimiques, de benzène, des diluants, des insecticides, ou des autres solvants peuvent causer les dommages à l'extérieur ou les déformations. Le caoutchouc ou le PVC qui ont beaucoup de contact avec le SLS PCS causeront les dommages. N'utilisez jamais les nettoyeuses avec pétrole ou les nettoyeuses abrasives.*
- *N'utilisez jamais les matérielles abrasive.*
- *Toujours dilatez les nettoyeuses par les instructions du fabricant ou utilisez la concentration le plus faible.*
- *Ne laissez pas les nettoyeuses à la surface de l'appareil pour longtemps. Donnez un coup d'éponge propre.*

Pour instructions d'entretien, regardez « Cleaning the Enclosure » sur la page 9-2.

Disinfecting Precautions

To avoid damage to the device, observe the following general precautions for disinfecting the device:

- Do not use Povodine, Sagrotan, or Mucocit disinfecting agents or strong solvents (for example, acetone).
- Do not use any disinfecting agents that corrode or damage polycarbonate.

Précautions de Désinfection

- *Pour éviter les dommages à l'appareil, regardez les précautions de désinfection.*
- *N'utilisez pas de Provoidine, du Sagrotan, ou de Mucocit désinfectant ou les solvants fortes*
- *N'utilisez pas les désinfectants qui corrodent le polycarbonate.*

Media Precautions

- Unwanted labels should be destroyed or disposed of to ensure that improper labels are not used.
- Only use Codonics ink cartridges and labels to ensure proper operation of the device and proper labeling of syringes. Using unapproved ink cartridges and labels could lead to unacceptable results, including poor print quality and poor label adhesion to syringes.
- Damage from unapproved ink or labels will void the warranty.
- Never refill ink cartridges, as this can result in incorrect color usage.

Précautions de Média et Consommables

- *Les étiquettes inutilisées doivent être disposées ou détruites donc les étiquettes mauvaises ne sont pas à utiliser.*
- *Utilisez seulement les cartouches et étiquettes Codonics pour faire certain que le SLS PCS fonctionne comme il faut.*
- *Tous les dommages causés par l'utilisation de cartouches d'encre ou d'étiquettes non approuvées annuleront la garantie.*
- *Ne rechargez jamais les cartouches. Ça peut avoir pour résultat des couleurs incorrectes.*

Disposal Requirements

Disposal of this product and consumables shall be in accordance with all applicable laws and regulations in effect at the locality at the time of disposal. For additional information, refer to Appendix A, Hazardous Material Information.

Conditions et Règles d'Utilisation

L'utilisation de ce produit doit être conforme à toutes les lois et règlements applicables sur le lieu d'utilisation.

European Disposal Requirements

Codonics imagers and electronic accessory devices are not to be discarded or recycled; rather they are to be returned to the manufacturer. Contact Codonics directly or by the link provided for the latest information concerning:

- Identification of the country-specific Importer/Distributor/Producer
- Product return and treatment of our electronic products

Manufacturer: Codonics Inc.
17991 Englewood Drive
Middleburg Heights, OH 44130 USA
Phone: +1 440.243.1198
Fax: +1 440.243.1334
E-mail: WEEE@codonics.com
www.codonics.com

Codonics electronic products and accessories bearing the following symbol are subject to European Directive on Waste Electrical and Electronic Equipment (WEEE) 2002/96/EC, amended by Directive 2003/108/EC. The EN 50419 symbol indicates separate collection and return required.



EN 50419 symbol

Indications for Use

Device Description

Drug preparation and administration in the perioperative environment are integral aspects of anesthesiologist's patient care responsibilities. The Codonics Safe Label System (SLS) is a simple, integrated system utilizing a barcode scanner to read and confirm drug identity from FDA NDC (National Drug Code) and other drug ID Barcodes from drug containers and automatically print labels for prepared drugs and other items in use on patients during surgical procedures. The labels are compliant with national regulations focused on improving medication safety in the perioperative environment.

The software components provide functions for scanning container barcodes; creating, reviewing, and approving the hospital-managed promotion of a formulary database; displaying on-screen and audibly confirming drug type; and printing ISO, ASTM, and TJC (The Joint Commission) content- and color-compliant labels with 1D and/or 2D barcodes. The system reads drug container barcodes and produces water resistant, color labels. The system can be integrated to function with an Anesthesia Information Management System (AIMS) workflow to provide real-time documentation of drug administration when the syringe 1D or 2D barcode is read. The system can be accessed and managed via a network (Ethernet or Wi-Fi).

Device Characteristics

The use of drug class specific pattern and color per ASTM D4774 and ISO 28625 Specifications for User Applied Drug Labels in Anesthesiology is configurable by site and dataset. *Formularies* (datasets) are uniquely named configurations that may differ in drugs, colors, dilutions, and comments to accommodate different practices within a single site or hospital (for example, pediatric versus cardiac).

Additional uses include producing labels for IVs and other artifacts used during a surgical procedure.

The Codonics SLS is generally placed in, however not limited to, the perioperative environment to identify syringes prepared for anesthesiology use during surgery.

Typical users of this system are trained professionals, including but not limited to physicians, nurses, and technicians.

The major characteristics and functions of the family of devices include:

- Scanning the drug container barcode directly from a vial or other type of container
- Decoding the manufacturer-issued barcode into the required FDA National Drug Code (NDC) or Unique Drug Identifier (UDI) number
- Referring the NDC/UDI number to a site-managed formulary lookup database
- Providing audio and ISO-compliant visual “readback” of the drug name
- Providing an alert if the drug container is listed as “recalled/obsolete” in the site’s formulary
- Printing an easy-to-read, water resistant ISO 26825 compliant color label meeting The Joint Commission medication management standards and the American Society of Anesthesiologists guidelines for labeling
- Providing the basic information by which the printed label barcode can be read to document medication administration in an AIMS
- Printing labels with insertion and expiration date and time for IV lines
- The SLS 600i PCS is prewired for future upgrades to support RFID reading and writing

Device Indications for Use Statement: Prescription Use Device

The Codonics SLS PCS device and SLS software provides a simple computer-based barcode scanning and printing system to automatically verify drug identity from NDC and other drug container UDI barcodes, and to print labels for prepared drugs and other items in use on patients during surgical procedures.

The Codonics SLS PCS is generally placed in, however not limited to, the perioperative environment to identify syringes prepared for anesthesiology use during surgery. Additional uses include producing labels for IVs and other artifacts used during a surgical procedure. SLS PCS can also be used to print “non-surgical environment” color and text labels as required. Typical users of this system are trained professionals, including but not limited to physicians, nurses, and technicians.



CAUTION Federal law restricts this device to be sold for use by or on the order of a physician.

1

Introduction

Welcome and Congratulations

Congratulations on your purchase of the Codonics® Safe Label System® Point of Care Station (SLS PCS) medication labeling system!



We are pleased that you chose SLS PCS. We are confident that it will provide safe, compliant, and fast medication labeling.

Product Features

Drug preparation and administration in the perioperative environment are integral aspects of anesthesiologist's patient care responsibilities. SLS PCS is a simple, integrated system utilizing a barcode scanner to read and confirm drug identity from FDA NDC (National Drug Code) and other drug ID barcodes from drug containers and automatically print labels for prepared drugs and other items in use on patients during surgical procedures. The labels are compliant with national regulations focused on improving medication safety in the perioperative environment.

The software components provide functions for scanning container barcodes; creating, reviewing, and approving the hospital-managed promotion of a formulary database; displaying on-screen and audibly confirming drug type; and printing ISO, ASTM, and TJC (The Joint Commission) content- and color-compliant labels with 1D and/or 2D barcodes. The system reads drug container barcodes and produces water resistant, color labels. The system can be integrated to function with an Anesthesia Information Management System (AIMS) workflow to provide real-time documentation of drug administration when the syringe barcode is read. The system can be accessed and managed via a network (Ethernet or Wi-Fi).

Hardware Features

- **Integrated printer** produces syringe labels that include medication name and concentration; dilutions and diluents; preparation time and date; preparer; and expiration time and date.
- **Embedded computer** including USB and an integrated speaker.

- **Touch screen display** with an intuitive, easy-to-use interface. System operation and status information is easily accessible from the touch screen interface.
- **Barcode scanner** identifies medications.
- **High-quality Codonics SLS inkjet cartridge and labels** provide reliable printing and adhesion for syringe labeling.
- **Convenient label media and ink cartridge access** is provided for ease of replacing labels and ink.
- **System operation and status information is easily accessible** from the touch screen interface.
- **Network capabilities via Ethernet or optional Wi-Fi** allow remote updating of SLS formulary, configuration, from the SLS Administration Tool.
- The SLS 600i PCS is prewired for future upgrades to support RFID reading and writing.

Operational Features

- **Easy to service** with Codonics Return to Factory Warranty. An optional DepotSwap Warranty program is also available, which provides a replacement SLS PCS if the problem cannot be solved by our Technical Support team. Also, the SmartDrive allows all configurations settings to be quickly transferred to a replacement SLS PCS. This minimizes downtime and reconfiguration effort.

2

Setting Up the System

Finding a Location for the System

When finding a suitable location for the system, use the following guidelines:

- Place the system in a location with adequate air circulation to prevent internal heat build up.
- Do not place the system near heat sources such as radiators or air ducts, or in a location subject to direct sunlight, excessive dust, mechanical vibration, or shock.
- Do not block air ventilation at the rear of the system.
- Make sure that the countertop or work surface supporting the system is level, can support the weight, and will not vibrate or shake when the system is operating.
- The device has mounting holes designed to be compatible with VESA mounting capabilities. Refer to www.vesa.org for mounting options and instructions.

Shipped Components

SLS PCS is shipped in cartons that contain the following system components:

- The SLS PCS device
- Supporting documentation package (including the SLS Quick Reference, Warranty, and support documents)

The following items are found in the Accessory Kit box:

- Label media hubs
- Output tray
- External power supply and cord
- SmartDrive USB flash drive
- Ethernet cable
- Reference Guide and other printed documentation
- Software and User's Manuals disc

Some configurations also include a Starter Kit that has one ink cartridge and one label media.

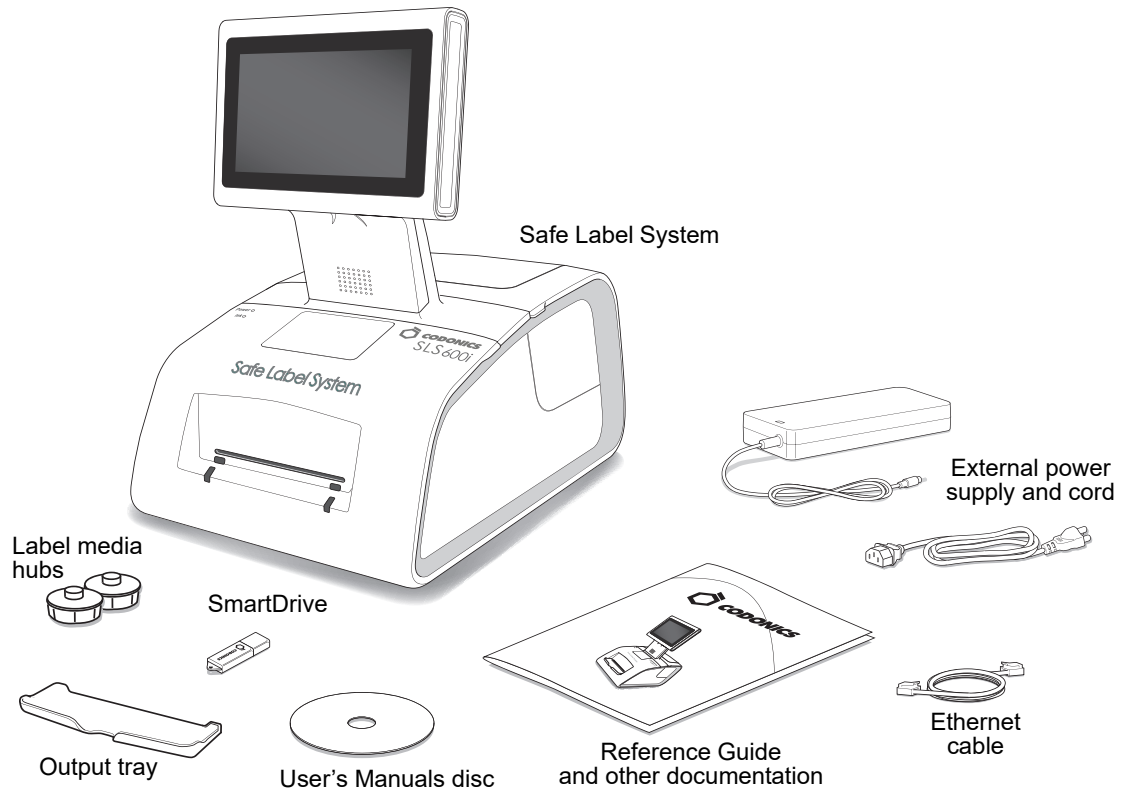

Unpacked components

Inspect the cartons for damage that might have occurred during shipping. Report any damage to the shipping company.

Save the cartons and packing materials, in case you ever need to transport SLS PCS later.



CAUTION When removing SLS PCS, hold under the front and rear of the system. Do not lift the system by the foam packaging.

Identifying the Components

SLS PCS Front Components

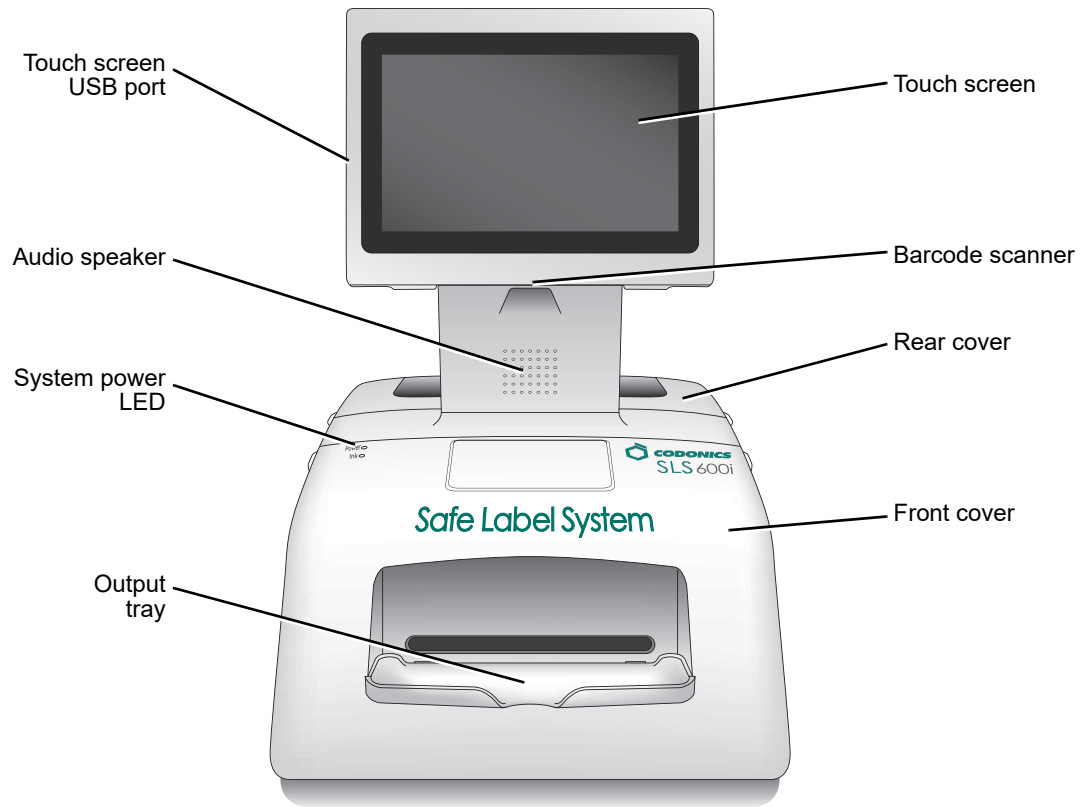

SLS PCS front components

- The **Touch Screen** displays the user interface to the system.
- The **Touch Screen USB Port** is used to install formulary update packages, configuration update packages, and software updates stored on USB flash drives.
- The **Audio Speaker** is used to announce drug names when a drug container's barcode is scanned, system messages, and other audio sounds.
- The **Barcode Scanner** scans drug container barcodes for identity and verification.
- The **Rear Cover** provides access to the label rolls.
- The **System Power LED** indicates when the system is powered on.
- The **Front Cover** is a durable plastic cover that protects SLS PCS from dust and accidental user interference while operating.



WARNING When the front cover is open, avoid contact with the label cutter.

- Printed labels are placed in the **Output Bin**.

Components Inside SLS PCS Front Cover

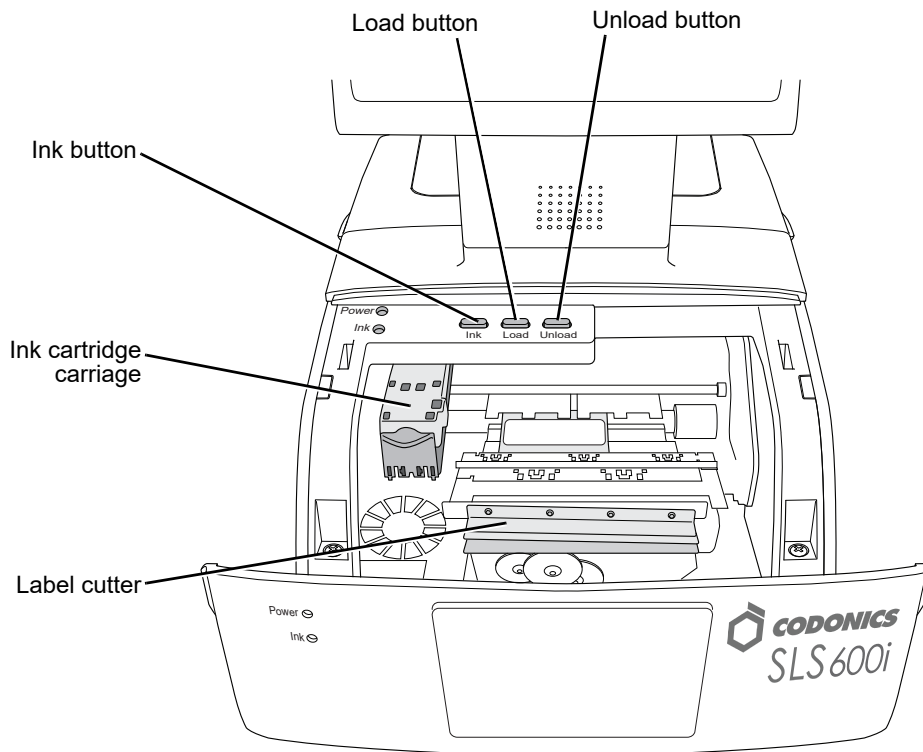

Components inside SLS PCS front cover

- Pressing the **Load Button** feeds the label media through SLS PCS and advances the labels.
- Pressing the **Ink Button** positions the ink cartridge carriage for easy ink cartridge replacement.

- Pressing the **Unload Button** unloads the installed label media by reversing it through SLS PCS.
- The **Ink Cartridge Carriage** holds the ink cartridge.
- The **Label Cutter** cuts the label after it is printed.



WARNING When the front cover is open, avoid contact with the label cutter.

- The wiring and connector on the inside of the front cover is for future RFID capability.

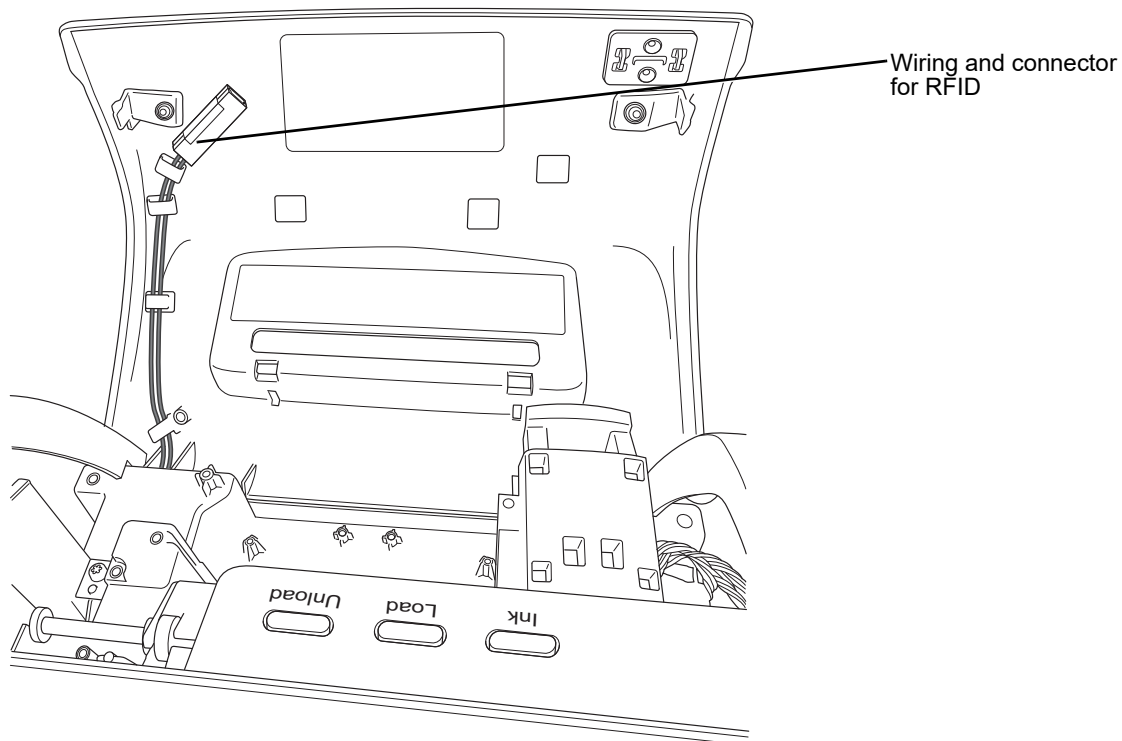

SLS PCS Rear Components

The following illustrations show the input/output ports and the power switch located at the rear of SLS PCS.

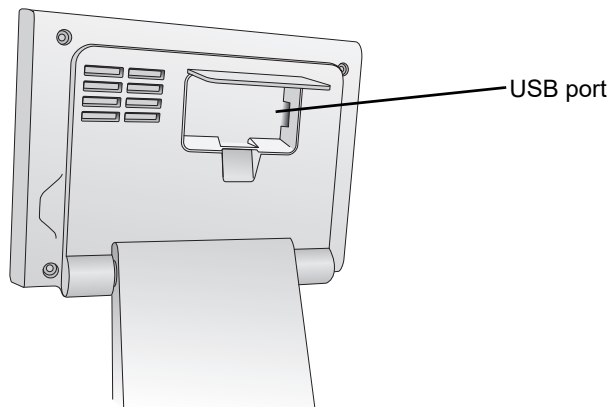

USB port, behind touch screen rear panel door

- The **USB port** behind the rear panel door is used to mount the SmartDrive flash drive.

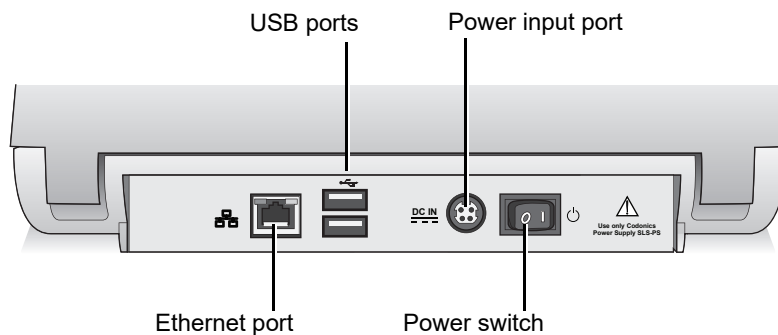

SLS PCS rear panel ports and Power switch

- The **USB ports** on the rear panel are used to connect third-party devices.
- The external power supply connects to the **Power input port**. The external power supply is a switching 100-V~240-V power supply.
- The **Power switch** powers SLS PCS on and off.
- The **Ethernet port** can be used to connect SLS PCS to a network.

SLS PCS Wi-Fi Adapter USB Port

The following illustration shows the USB ports for the optional Wi-Fi adapter, located at the bottom front right corner of SLS PCS.

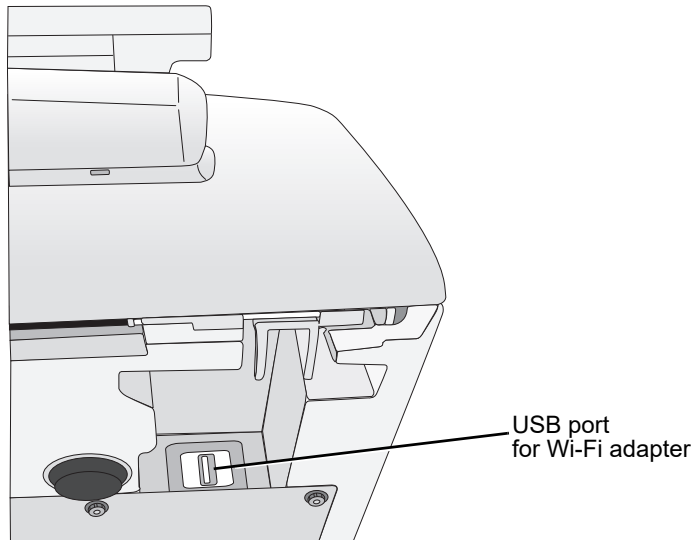

USB ports for Wi-Fi adapter, at the bottom front right corner of SLS PCS

MAC Address Label Locations

The MAC address might be needed by your SLS administrator when configuring the SLS PCS network connection.

The Ethernet MAC address label for SLS PCS is located inside the front cover, as shown in the following illustration.

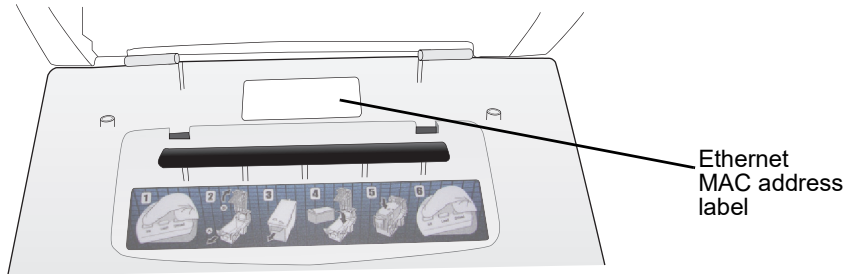

Ethernet MAC address label location, inside front cover

If using the optional Wi-Fi network connection, the Wi-Fi MAC address label for SLS PCS is located on the Wi-Fi adapter that is inserted into the SLS PCS Wi-Fi adapter USB port.

Touch Screen

The following illustration shows the touch screen Power LED, the Reset button, and the USB port at the left side of the touch screen.

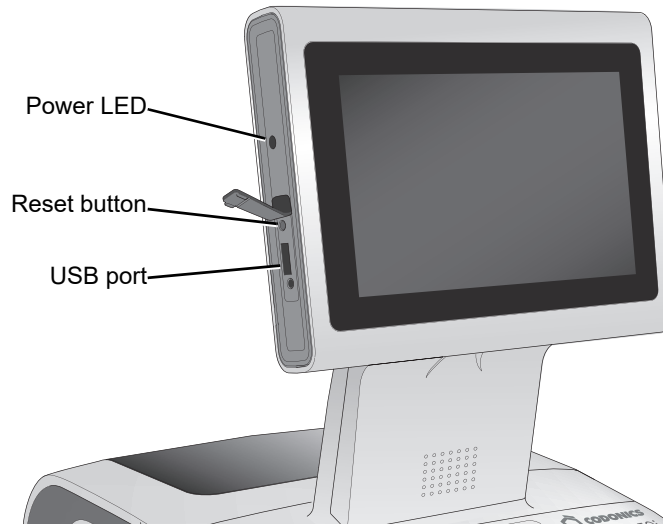

Reset button and USB port at left side of touch screen

- The **Power LED** lights when the touch screen is powered on.
- The **Reset button** is used to reboot the system software in the event of a critical failure. If required, use a pen or other pointed tool to press the Reset button.



NOTE: Do not use the Reset button unless directed to do so by Codonics Technical Support.

- The **USB port** is used for connecting USB flash drives that contain software and formulary updates.

Connecting the Ethernet Cable (Optional)

If you are connecting SLS PCS to a network using Ethernet, then you must connect an Ethernet cable to the SLS PCS.



NOTE: SLS PCS supports only Full Duplex 100 Base-T Ethernet.



To connect the
Ethernet cable

1. Connect one end of the Ethernet cable to an Ethernet hub or other Ethernet outlet that is connected to the network.

2. Plug the other end of the Ethernet cable into the Ethernet port on the rear panel of SLS PCS.

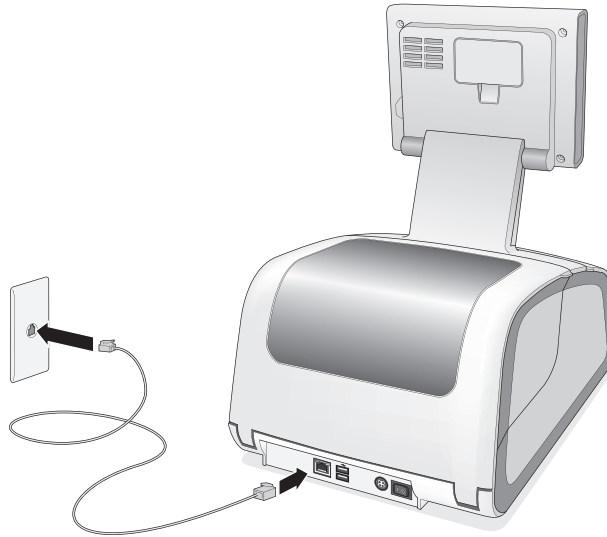

Connecting the Ethernet cable

For information about configuring the Ethernet network settings, refer to “Configuring an Ethernet Network Connection” on page 4-3.

Connecting the Wi-Fi Adapter (Optional)

If you are connecting SLS PCS to a network using Wi-Fi, then you must connect the Wi-Fi adapter to SLS PCS.



To connect the
Wi-Fi adapter

1. Locate the USB ports for the Wi-Fi adapter at the bottom front right corner of SLS PCS.
2. Insert the Codonics Wi-Fi adapter (catalog number SLS500-WIFI) into one of the USB ports.

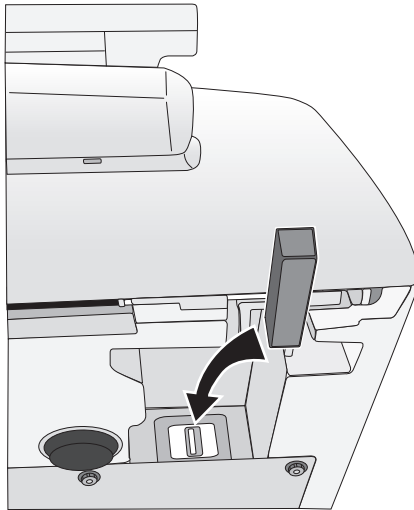

Connecting the Wi-Fi adapter



NOTE: The Wi-Fi adapter must be inserted before SLS PCS is powered on for the Wi-Fi connectivity to work properly. If SLS PCS is powered on when the Wi-Fi adapter is inserted, power SLS PCS off and then on again.

For information about configuring the Wi-Fi network settings, refer to either “Configuring an Enterprise Wi-Fi Network Connection” on page 4-9 or “Configuring a Non-Enterprise Wi-Fi Network Connection” on page 4-21.

Connecting the External Power Supply



To connect the external power supply

1. Locate the external power supply included with your SLS PCS.
2. Plug the external power supply into the Power Input port on the rear panel of SLS PCS.

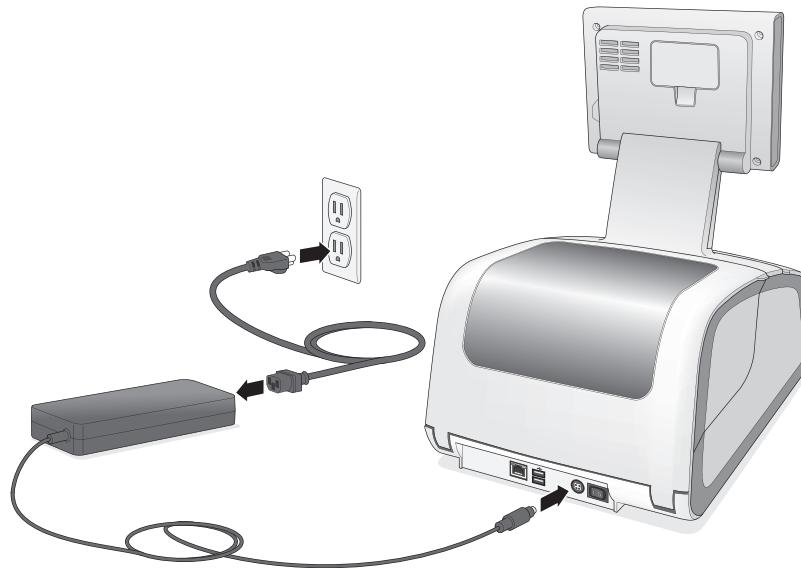

Connecting the external power supply

3. Connect the power cord from the external power supply to a grounded power outlet that supplies the appropriate voltage for the applicable country.



WARNING The power cord plug is the main disconnect for the device. The power outlet should be near the device and be easily accessible.



WARNING Remove the power cord plug from the power outlet to disconnect overall power to the device.



WARNING Grounding reliability can be achieved only when SLS PCS is connected to a receptacle marked “Hospital Only” (that is, “Hospital Grade”).

Once the external power supply is connected, SLS PCS can be powered on and off using the Power switch on the rear panel.

Inserting the SmartDrive



Insert the SmartDrive into the USB port inside the touch screen rear panel door.

To insert the
SmartDrive

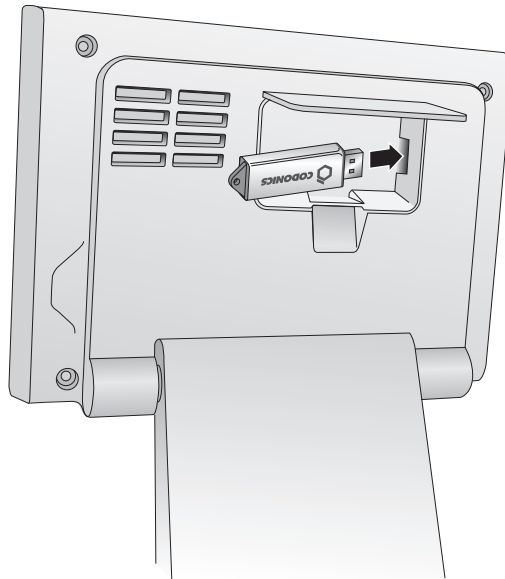

Inserting the SmartDrive into the USB port inside the touch screen rear panel door



NOTE: *The rear panel door is not intended to be removed.*

Starting Up the System



To start up the system

1. Press the Power switch on the rear of SLS PCS to power on and start up the system.

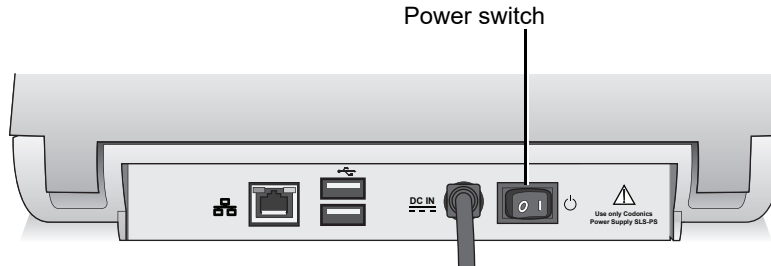

Power switch on the rear panel

When SLS PCS has completed its startup successfully, you are prompted to verify that the date and time are correct.

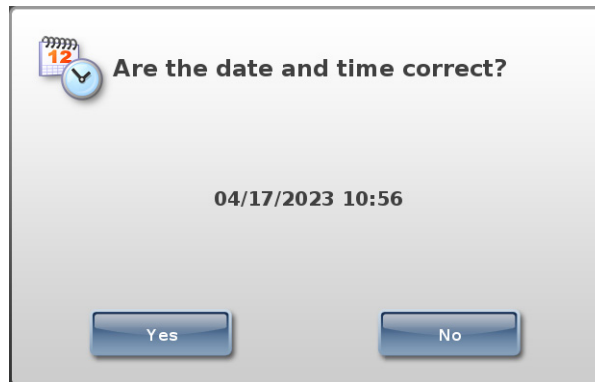

2. Press **Yes** if the date or time is correct.

The Login screen displays.

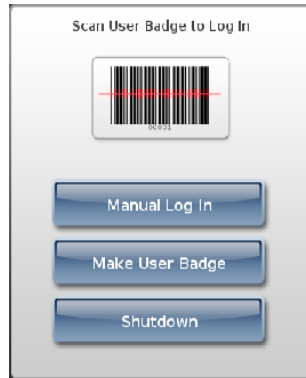

- Press **No** if the date or time is incorrect.

Controls for changing the date and time display.

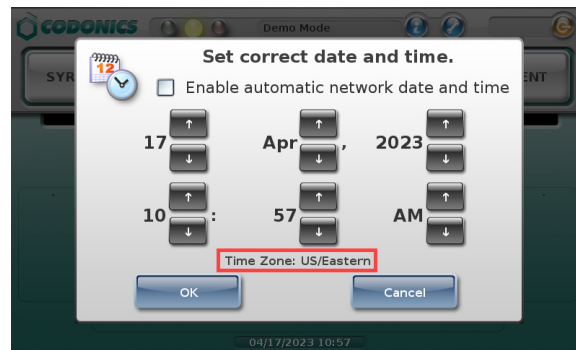

Note that when SLS PCS is configured for a specific time zone, it is displayed below the controls.

3. Use the controls to correct the date and time, then press the **OK** button.

The Login screen displays.



NOTE: If the SLS Administration Tool Device Manager is being used to monitor the status of this SLS PCS, make sure that the date/time entered is the same as that on the PC on which the SLS Administration Tool is running. If SLS PCS is more than 30 days behind the SLS Administration Tool, no SLS PCS events will be reported to Device Manager. If the SLS PCS date is within 30 days but not the same, event reporting will not be optimal.



NOTE: If the system detects that the SmartDrive contains a newer version of software, or that a USB flash drive contains an update package, you will be prompted to install the update. For more information, refer to "Installing Update Packages" on page 9-5.

Installing the Ink Cartridge

The dashboard on SLS PCS touch screen indicates when there is a low ink condition: The System status light is yellow and the status message text reports that the system is low on ink.

If there is no ink, the System status light will be red. During setup, this will be the condition until the ink cartridge is installed.



NOTE: SLS PCS is designed to work only with Codonics ink cartridges. To order ink cartridges, refer to "Ordering Supplies and Parts" on page 9-1. Using unapproved ink cartridges could lead to poor print quality and incorrect label colors.



NOTE: Never refill ink cartridges, as this can result in incorrect color usage and cause improperly printed labels.



NOTE: To prevent ink cartridges from drying out when opened, follow these instructions for installing the ink cartridge.



To install an ink cartridge

1. Open the front cover.
2. Press the Ink button.

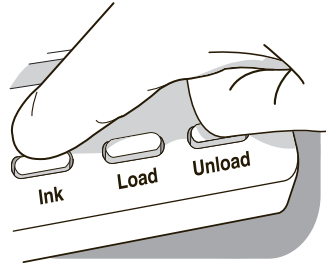

Ink button

3. Wait for the ink cartridge carriage to move to the right.

4. Open the carriage cover by pulling out on the purple hold-down clip. The cover is spring-loaded and will pop open.

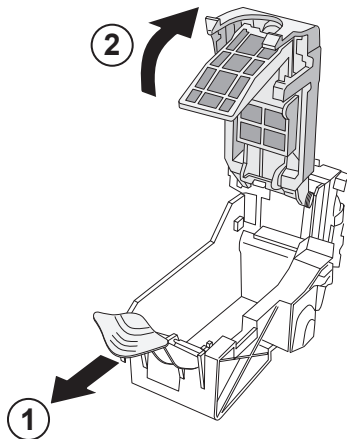

Opening the ink cartridge carriage cover

5. Remove the ink cartridge from its packaging. Once the ink cartridge is removed from its package, hold it by its sides.

6. Slowly remove the tape covering the cartridge's print head.

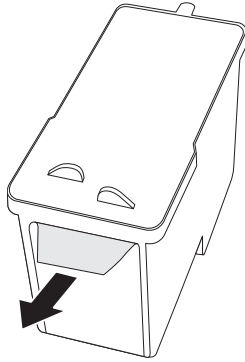

Removing ink cartridge print head tape



CAUTION Do not touch the copper area of the cartridge print head.

7. Insert the ink cartridge into its carriage, copper end first.

Hold the cartridge at a 45° angle as you slide it into its carriage, then push the cartridge down and toward the back until it fully drops into place.

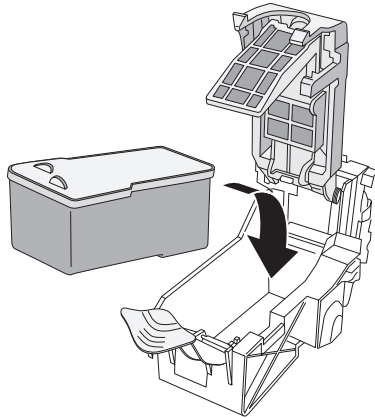

Loading the ink cartridge

8. Close the carriage cover until it snaps into place and is secured by the purple hold-down clip.

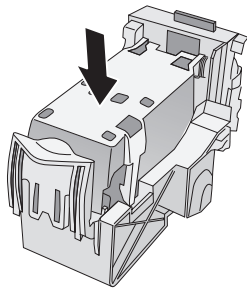

Carriage cover closed

9. Press the Ink button.

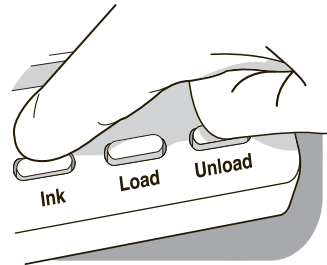

Ink button

10. Close the front cover.

Loading or Replacing the Label Media



NOTE: Use only Codonics labels to ensure proper operation of the device and proper labeling of syringes. Using unapproved labels could lead to unacceptable results, including poor print quality, ~~and~~ poor label adhesion to the syringe, and label jams.



NOTE: Unwanted labels should be destroyed or disposed of to ensure that improper labels are not used.



To load or
replace label
media

1. If the last label in the media roll is in the process of being printed, wait until the roll liner has finished rewinding before opening the rear cover.

This will prevent the label from not being cut and getting stuck inside SLS PCS. For more information, see “End of Media Roll Behavior” on page 2-30.

2. Open the rear cover.
3. Optionally, remove the rear cover for better access to the media path. For more information, refer to “Removing the Rear Cover” on page 9-12
4. Remove the loaded label media and hubs from the media guides.

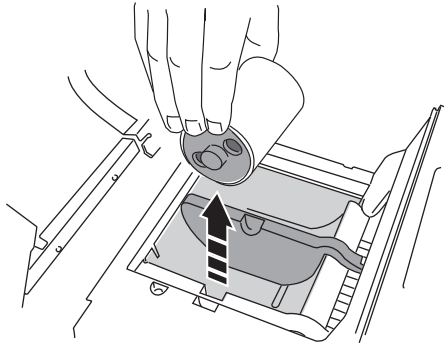

Removing the loaded label media

5. Remove any shipping tape or rubber bands from the new label media to ensure that it can unroll freely, making certain that no adhesive portion is exposed.



NOTE: Any exposed adhesive surface can attach itself to the inner workings of the print mechanism and cause a label jam.

6. Insert the hubs into the label media.

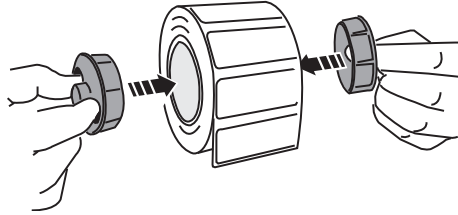

Inserting the hubs into the label media

7. Place the label media with hubs into the media guides.

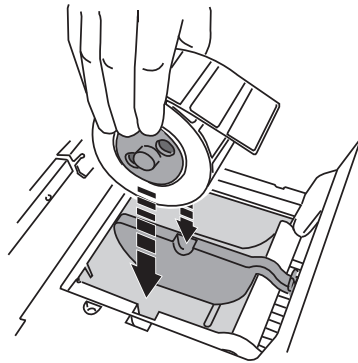

Placing the label media with hubs into the media guides

8. Adjust the media guides into position to securely hold the label media while allowing it to turn freely.

9. Place the leading edge of the label media below the two top media guides and into the feeder slot.

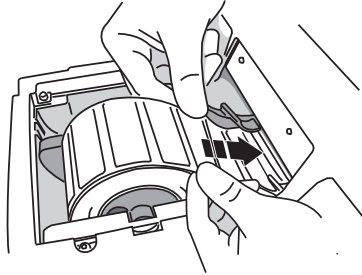

Placing the label media leading edge into the feeder slot

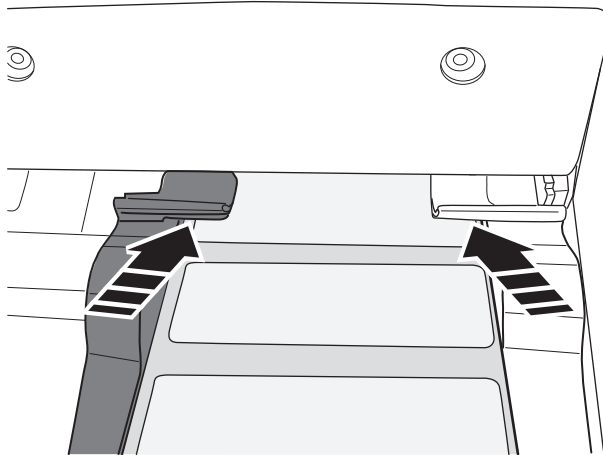

Label media fed beneath media guides

10. Feed the label media leading edge further into the feeder slot until SLS PCS senses the labels and automatically feeds them through. You might need to hold the label media in place for a few seconds.



NOTE: If SLS PCS fails to feed the label media, open the front cover, press the Unload button (shown below), remove the media from the media path, wait until the media path rollers stop spinning, and try loading the media again. If needed, press the Load button as you feed the media beneath the media guides.

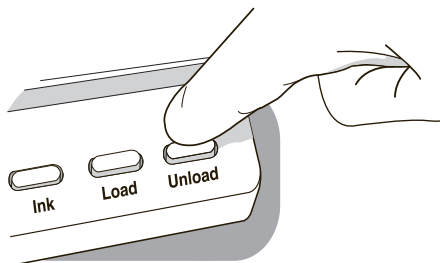

Unload button

End of Media Roll Behavior

At the end of a media roll, SLS PCS prints the last label, waits 10 seconds, cuts the last printed label, and then automatically rewinds the remaining liner.

You can then open the rear cover of SLS PCS, remove the media core, and load a new roll of media.

If you open the rear cover before the last label (or strip of labels in Batch Mode) is cut and press the Unload button, then SLS PCS will not cut the labels; it will only rewind the roll. If the last label has not been cut, there is a risk that, as the roll rewinds, a label could peel off and become stuck inside SLS PCS. Make sure that the last label has been cut before opening the rear cover to replace the media.

SmartDrive and Stored Information

The SLS SmartDrive is a USB flash drive that holds critical SLS information, including configuration data and log files.



CAUTION The SmartDrive must be inserted for the system to operate. If the SmartDrive is not inserted, the system can start up but will not be able to process jobs. A message at the touch screen will prompt you to insert the SmartDrive.

The SmartDrive also allows you to move the configuration files of one SLS PCS to another SLS PCS, thus allowing the second SLS PCS to operate exactly like the first. This feature is especially helpful when swapping an SLS PCS for service purposes.



NOTE: A SmartDrive cannot be duplicated. That is, it cannot be used in two SLS PCS units at the same time.

Information Stored on the SmartDrive

The SLS SmartDrive stores the following information:

- **The SLS Software License Code.** This is the serial number for the SLS software. All keyed features are keyed from the License Code.
- **The SLS Configuration.** This includes all of the system's configuration settings.
- **Formulary database.** This is a backup copy of the formulary database that is stored in SLS PCS.
- **User database.** This is a backup of the user database that is stored in SLS PCS.

- **Tracking database.** This is the database that is used to track user events (for example, when a user logs on or off the system, or when a user prints a label).
- **Log files.** These include installation logs, system logs, and event audit logs.

The SLS configuration, formulary database, tracking database and log files that are stored on the SmartDrive are encrypted to ensure the security of the data.

Events That Synchronize Data to the SmartDrive

The following events trigger a synchronization of SLS PCS data with that stored on the SmartDrive:

- Automatically every 15 minutes
- Shutting down the system
- Formulary updates

3

Basic Operations



CAUTION Users should read and understand all safety warnings and operating instructions prior to using the system.

Making a User Badge

At the Login prompt, you can choose to make and print a user badge for yourself. You can then log in to any SLS PCS by scanning the barcode on the badge. If you have already made a badge and just need to reprint it, refer to “Printing a User Badge” on page 3-23.



1. At the Login prompt, press the **Make User Badge** button.

To make a user badge

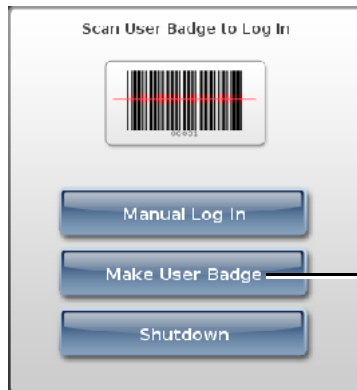

Press **Make User Badge**

You are prompted to enter your user information.

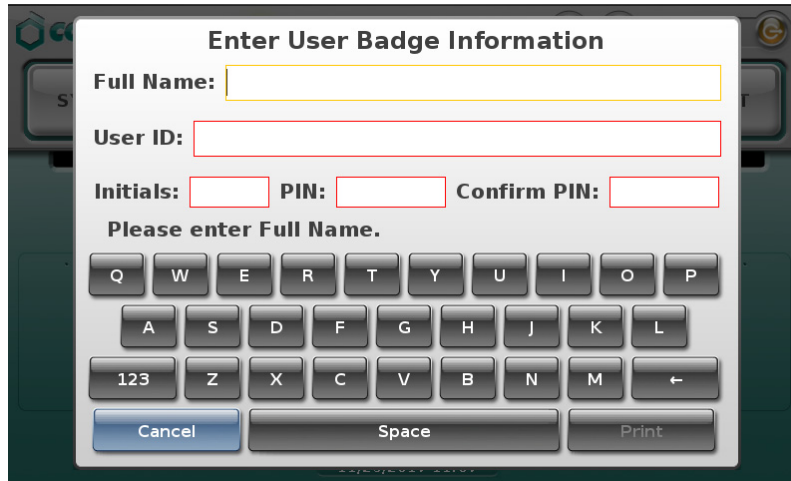

The screenshot shows a dialog box titled "Enter User Badge Information". It contains the following fields and controls:

- Full Name:** A text input field with a yellow border.
- User ID:** A text input field with a red border.
- Initials:** A text input field with a red border.
- PIN:** A text input field with a red border.
- Confirm PIN:** A text input field with a red border.
- Text:** "Please enter Full Name."
- Keyboard:** An on-screen keyboard with keys for Q, W, E, R, T, Y, U, I, O, P; A, S, D, F, G, H, J, K, L; 123, Z, X, C, V, B, N, M, and a back arrow.
- Buttons:** "Cancel", "Space", and "Print".



NOTE: If instead of the Enter User Badge Information screen a message displays saying this function is disabled, contact your SLS administrator about how to obtain a user badge.

2. Enter user information by pressing each field and using the on-screen keyboard.
 - The Full Name can be up to 38 characters long.
 - The User ID can be up to 16 characters long.
 - The Initials can be up to 3 characters long.
 - The PIN can be up to 10 digits long. If the system is not configured to require a PIN, then PIN fields will not be shown.
3. When you have entered your user information, press the **Print** button.

The badge is printed and placed in the output tray. The Login prompt is displayed.

Your user information is stored in the system. You can now use this badge to log in to any SLS PCS by scanning its barcode.



NOTE: The SLS system administrator needs to ensure that unique user IDs are assigned to each user.

Logging In

You log in by entering your user ID or by scanning the barcode on your user badge. For information about making a user badge, refer to “Making a User Badge” on page 3-1.



To log in

1. With the Login prompt displayed, enter your user ID using one of the following methods:

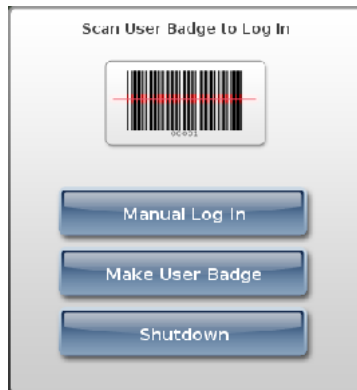

- Method 1: Press the **Manual Log In** button. Then go to step 2.
- Method 2: Scan the barcode on your user badge.



Scanning a user badge

If SLS PCS has been configured to require a PIN and one has not yet been created for your user ID, you are prompted to enter your PIN, which can be up to ten digits long. Go to step 4. Otherwise, a test label is printed and you are prompted to confirm that it printed correctly (the prompt is shown in step 5). Go to step 6.

2. Use the keypad to enter your user ID.

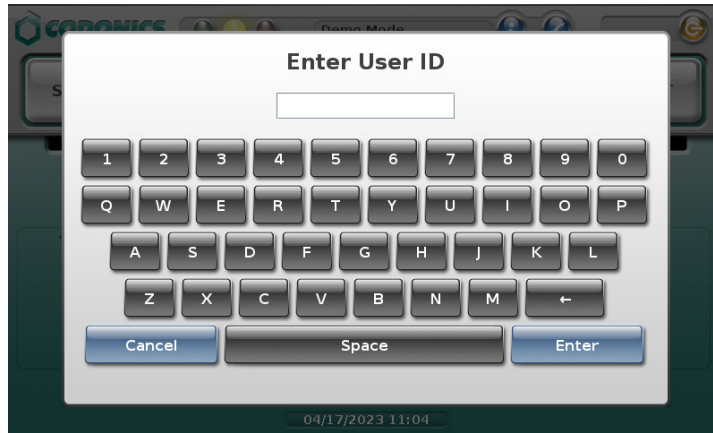

3. Press the **Enter** button

If SLS PCS has been configured to require a PIN and one has not yet been created for your user ID, you are prompted to enter your PIN. Otherwise, a test label is printed and you are prompted to confirm that it printed correctly (the prompt is shown in step 5). Go to step 6.

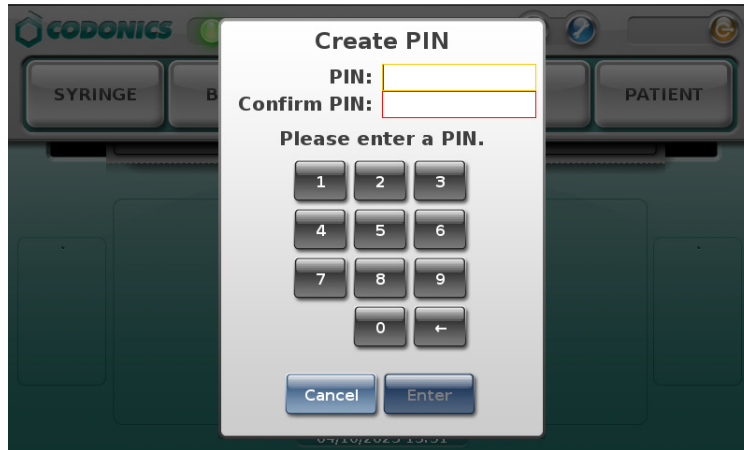

4. Enter your PIN.

The PIN can be up to 10 digits long.

5. Press the **Enter** button.

To ensure that labels print properly, the test print screen displays and a test label is printed.

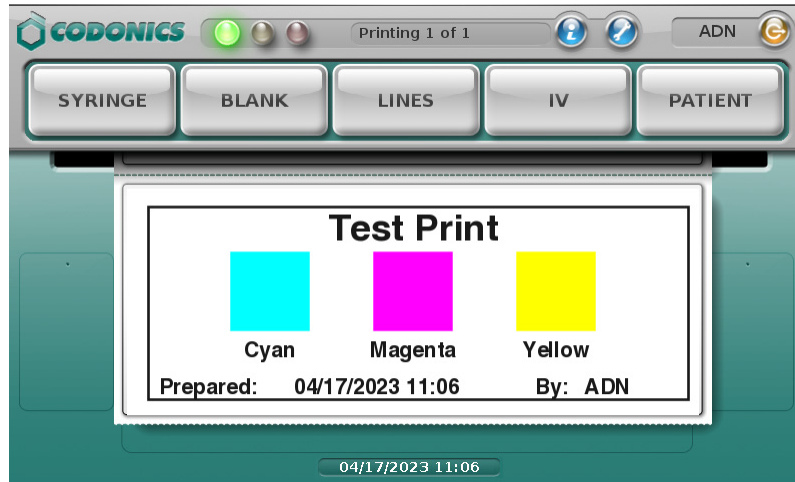

NOTE: *If the 24-hour test print setting is enabled, the system will ensure that a test print is performed at least once a day.*

You are then prompted to confirm the test label printed correctly.

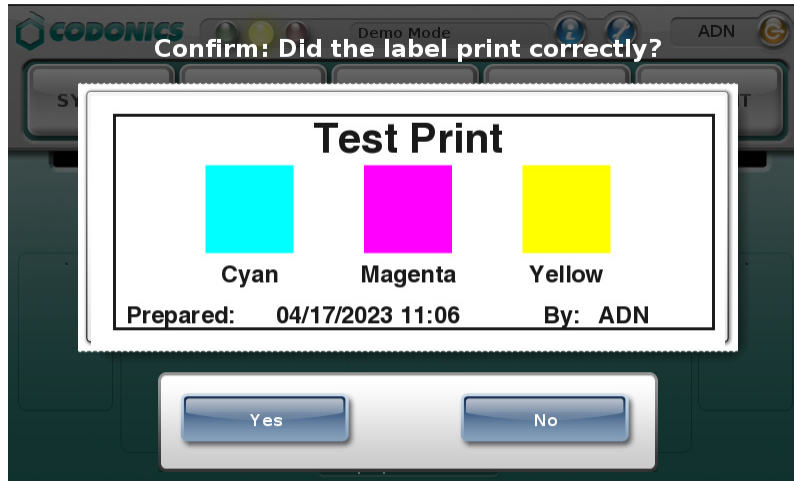

6. Review the following to ensure that the test label printed correctly:
 - The colors are correct
 - The label content is correctly centered
 - The print is not faded
 - There is no horizontal banding
 - The date and time are correct
 - The user's initials are correct

7. If the test label has printed correctly, press the **Yes** button.
The main screen displays and the system is ready for use.



If the test label prints incorrectly, press the **No** button.

A Test Print Failed Verification message displays.

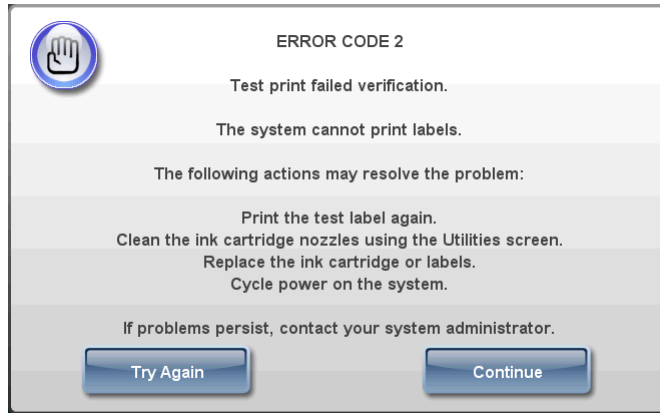

8. To **print another test label**, press the **Try Again** button.

Another test label prints and you are prompted again to confirm the test label.

To attempt to resolve the printing problem, press the **Continue** button.

The Utilities screen displays and SLS PCS is put into an out-of-service state.

9. To troubleshoot the printing problem and perform the recommended solution, refer to Table 10-2 on page 10-10.

The system cannot leave the out-of-service state until you press the **Yes** button in response to the prompt to confirm that the test label printed correctly. So, after each solution you try, print another test label. If the test label does not print automatically, you can log out and log in again to have the system print a test label.

10. If the test label still does not print correctly after trying the suggested solutions, contact your SLS system administrator.

Touch Screen User Interface

The elements of the main screen are identified in the following figure.

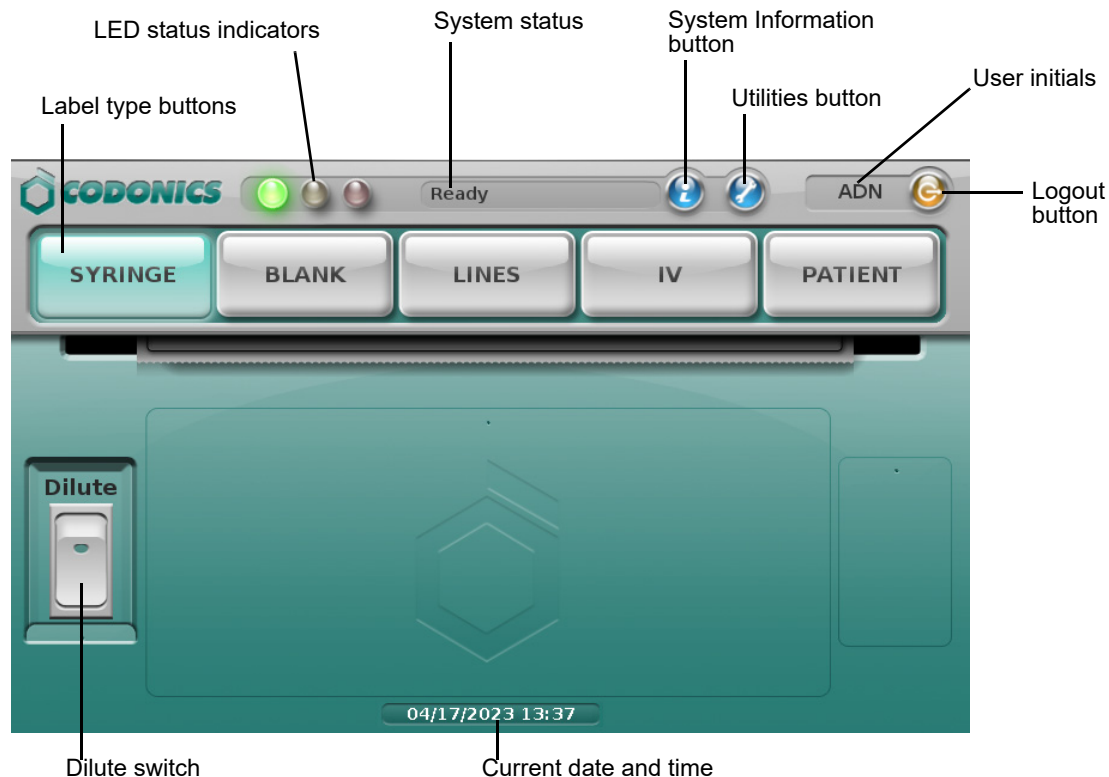

If the SLS600i supports Batch or Copy mode, a **Batch** or **Copy** button is included on the main screen. Refer to “Printing Labels in Batch Mode” on page 5-47 and “Printing Labels in Copy Mode” on page 5-56.

SLS Utilities

You can perform certain operations from the Utilities screen.



These operations include:

- Adjusting the audio volume. Refer to “Adjusting the Audio Volume” on page 3-37.
- Adjusting the touch screen brightness. Refer to “Adjusting the Touch Screen Brightness” on page 3-37.
- Setting Fast Print mode. Refer to “Setting Fast Print Mode” on page 3-22.
- Printing another copy of your user badge. Refer to “Printing a User Badge” on page 3-23.
- Setting the date and time. Refer to “Setting the Date and Time” on page 3-35.

There are other utilities functions that are used to maintain SLS PCS. These include:

- Cleaning the ink cartridge nozzles. Refer to “Cleaning the Ink Cartridge Nozzles” on page 3-15.
- Adjusting the label media path. Refer to “Adjusting the Media Path” on page 3-18.
- Setting the black levels of a printed label. Refer to “Adjusting the Label Black Levels” on page 3-20.
- Copying system log files to a USB flash drive. Refer to “Backing Up Log Files” on page 3-27.
- Clearing system errors. Refer to “Clearing Errors” on page 3-30.
- Adding SLS features. Refer to “Adding a Feature” on page 3-32.
- If SLS PCS is being run on a network, configuring its network settings. Refer to Chapter 3.



NOTE: The SLS 600i touch screen does not require calibration. If you press the **Calibrate Screen** button, the message “Calibration is not required for this touchscreen” displays.

Displaying the Utilities Screen



To display the Utilities screen

Press the **Utilities** button.



The Utilities screen displays.



Cleaning the Ink Cartridge Nozzles

If label print quality is poor, you might need to clean the ink cartridge nozzles.



To clean the ink cartridge nozzles

1. Press the **Utilities** button at the top of the user interface.



The Utilities screen displays.

2. Press the **Clean Nozzles** button.

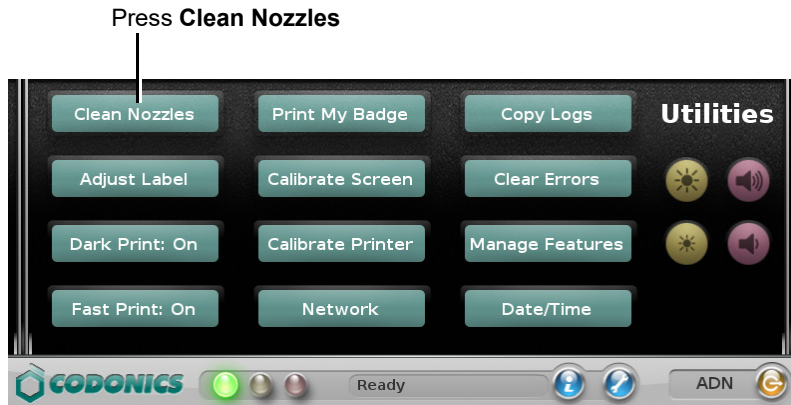

The system cleans the ink cartridge nozzles, and then prints a test label.

You are then prompted to confirm that the test label printed correctly.

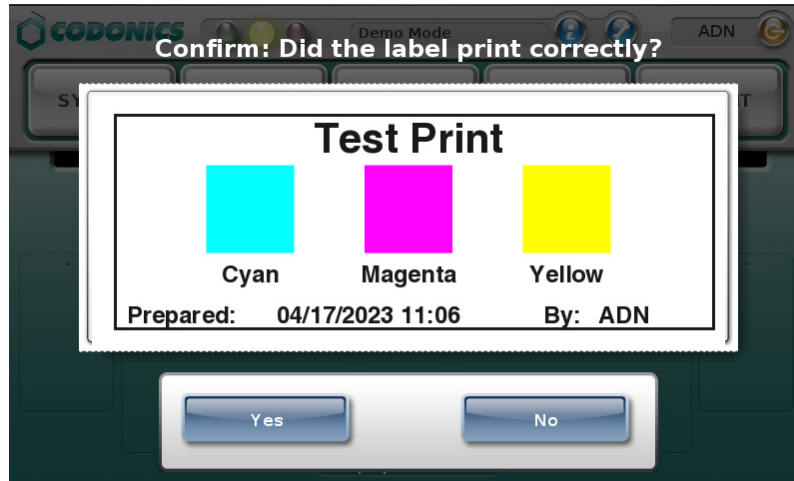

3. Review the following to ensure that the test label printed correctly:
 - The colors are correct
 - The label content is correctly centered
 - The print is not faded
 - There is no horizontal banding
 - The date and time are correct
 - The user's initials are correct
4. If the test label has printed correctly, press the **Yes** button.
The main screen displays.
If the test label prints incorrectly, press the **No** button.

A Test Print Failed Verification message displays.

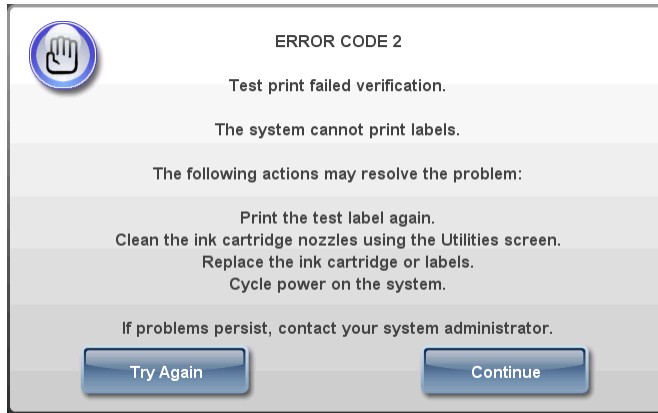

5. To print another test label, press the **Try Again** button.

Another test label prints and you are prompted again to confirm the test label.

To attempt to resolve the printing problem, press the **Continue** button.

The Utilities screen displays and SLS PCS is put into an out-of-service state.

6. To troubleshoot the printing problem and perform the recommended solution, refer to Table 10-2 on page 10-10.

The system cannot leave the out-of-service state until you press the **Yes** button in response to the prompt to confirm that the test label printed correctly. So, after each solution you try, print another test label. If the utility you use does not do this automatically, you can log out and log in again to have the system print a test label.

7. If the test label still does not print correctly after trying the suggested solutions, contact your SLS system administrator.

Adjusting the Media Path

If the label is not properly centered on the printed labels or the labels are not being cut at the proper location on the media, you might need to adjust the media path.



To adjust the media path

1. Unload the label media, as described in “Clearing a Label Media Jam” on page 10-24.
2. Press the **Utilities** button at the top of the user interface.



The Utilities screen displays.

3. Press the **Adjust Label** button.

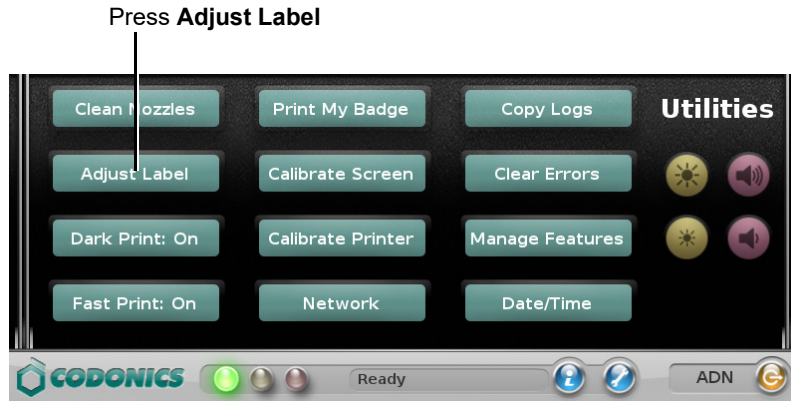

The **Adjust Label** dialog box displays.

4. Use the adjustment buttons as described in the following figure.

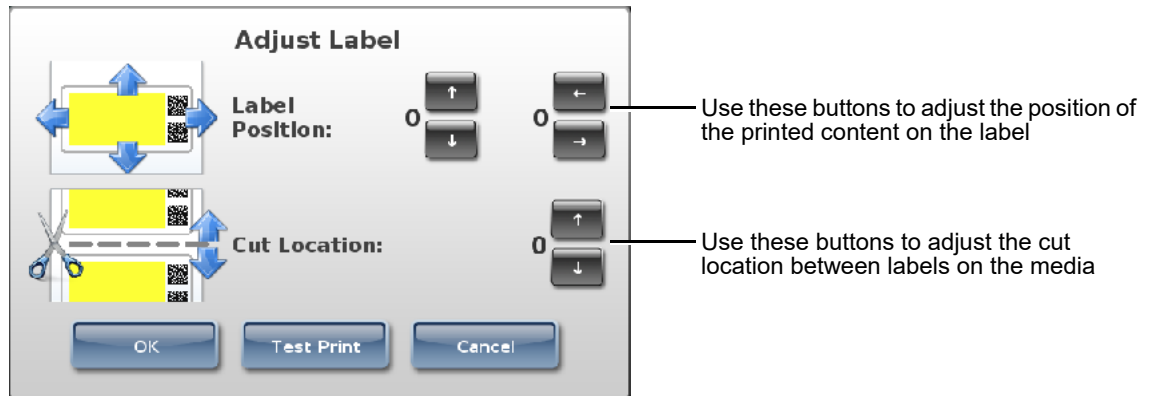

For example, if the label content is correctly centered horizontally but is too low on the label vertically, use the up arrow button to move the print area up on the label.

5. Optionally, press the **Test Print** button to print a label and check your adjustments.
6. After making the appropriate adjustments, press the **OK** button.
7. Close the Utilities screen.
8. Reload the label media, as described in “Loading or Replacing the Label Media” on page 2-26.
9. Print a custom label to see if the label prints correctly and use the Adjust Label utility again to make additional adjustments if needed.

Adjusting the Label Black Levels

You can adjust the black levels of printed labels to improve their print contrast. If ink bleeding or barcode printing issues occur, the black levels adjustment should be turned off.



To adjust the
label black
levels

1. Press the **Utilities** button at the top of the user interface.



The Utilities screen displays.

2. Press the **Dark Print: On** button (the button is in the **Dark Print: On** state by default).



Press **Dark Print: On**

The button label changes to **Dark Print: On**, which indicates that the black levels adjustment has been turned on and the black levels for labels decreased.

3. To turn off the black levels adjustment, press the **Dark Print: Off** button.

Setting Fast Print Mode

SLS PCS supports Fast Print mode, which uses fewer ink passes to print labels faster than in normal print mode. By default, Fast Print mode is on.



To set Fast Print mode

Press the **Fast Print** button to toggle it on or off.



Press **Fast Print**



NOTE: While in Fast Print mode, streaks or white lines might occur on the printed label if a nozzle is clogged. If the quality deteriorates to an unacceptable level, you can try purging the ink cartridge by selecting Clean Nozzles on the Utilities screen, replacing the ink cartridge, or turning off Fast Print mode.

Printing a User Badge



To print a user badge

Press the **Print My Badge** button.

Press Print My Badge



The user badge is displayed and then printed. The user badge will include your login barcode and name. Depending on how the user badges are configured, it can also include your user ID. If your user name is too long to fit on the badge, an ellipse indicates that the name has been truncated.

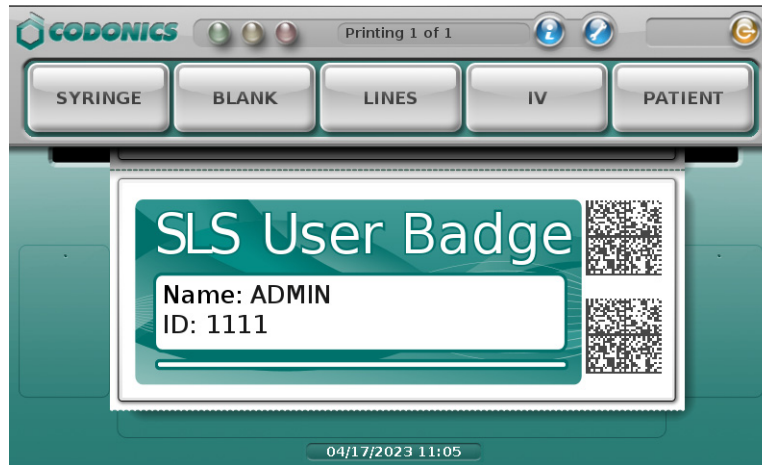

Calibrating the Printer

The Calibrate Printer utility calibrates the media loading path and the paper out sensor. Run the Calibrate Printer utility if you notice that labels are not loading properly or if the printer is not detecting that media is out.



To calibrate the printer

1. Press the **Utilities** button at the top of the user interface.



The Utilities screen displays.

2. Press the **Calibrate Printer** button.



The system displays a message with instructions about how to perform the calibration.

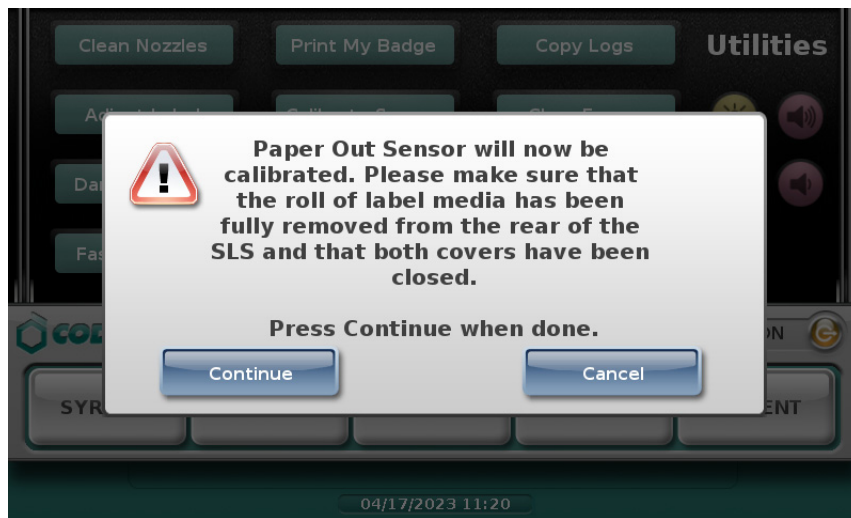

3. Remove the media roll and close the SLS PCS covers.
4. Press the **Continue** button to begin the calibration.

Configuring the Network

The **Network** button opens the Network utility. For information about how to use this utility, refer to Chapter 4, “Configuring the Network Connection”.

Backing Up Log Files

To prevent loss of the system logs stored on SLS PCS, it is strongly recommended that this data be backed up to another storage device on a regular basis. Also, if SLS PCS is experiencing problems, Codonics Technical Support might ask you to copy the system files to a USB flash drive and send them the drive.

Use the following procedure to copy the system files to a USB flash drive. You can then copy these files to another storage device for backup purposes.



CAUTION The system files copied to the USB flash drive are not encrypted.



To copy logs and other system files to a USB flash drive

1. Log in to SLS PCS, as described in “Logging In” on page 3-3.
2. Insert the USB flash drive into the USB port on the left side of the touch screen.

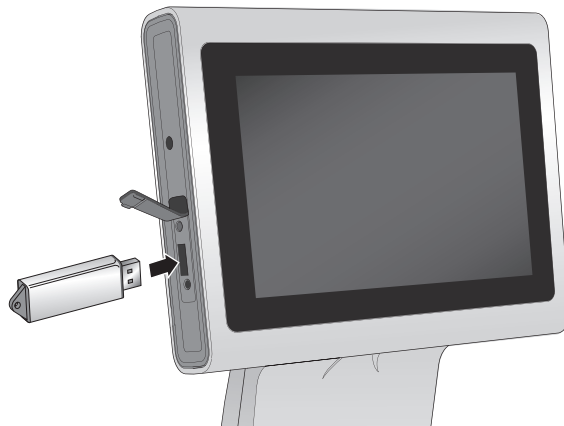

Inserting the USB flash drive into the touch screen USB port

3. Press the **Utilities** button at the top of the user interface.



The Utilities screen displays.

4. Press the **Copy Logs** button.



The system prompts you to confirm the copy operation.

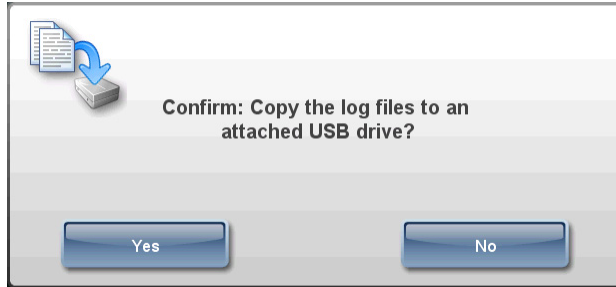

5. Press the **Yes** button to continue.

The system displays the progress of the copy operation.

6. When the copy operation is complete, press the **Utilities** button to close the Utilities screen.
7. Remove the USB flash drive.

Clearing Errors

Sometimes a permanent error state needs to be cleared in the SLS software.



NOTE: This function should only be performed by a qualified and trained SLS system administrator or in coordination with Codonics Technical Support.



1. Press the **Utilities** button at the top of the user interface.

To clear errors



The Utilities screen displays.

2. Press the **Clear Errors** button.



A confirmation dialog box displays.

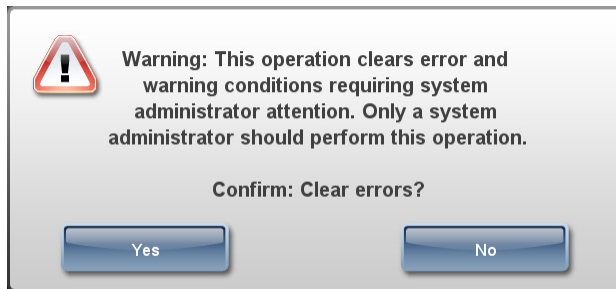

3. To continue with clearing the errors and restarting the system, press the **Yes** button. SLS PCS shuts down, restarts, and returns to the Login prompt.

Adding a Feature

Feature keys enable specific features of SLS PCS. Each feature key is associated with an integer value that identifies the name of the feature.

If you have purchased a new feature for SLS PCS, Codonics will provide you with the feature key.

The procedure for adding feature keys is provided below. Feature keys can also be installed remotely over the network from the SLS Administration Tool.



To add a feature

1. Press the **Utilities** button at the top of the user interface.



The Utilities screen displays.

2. Press the **Manage Features** button.



Press **Manage Features**

The **Manage Features** dialog box displays.

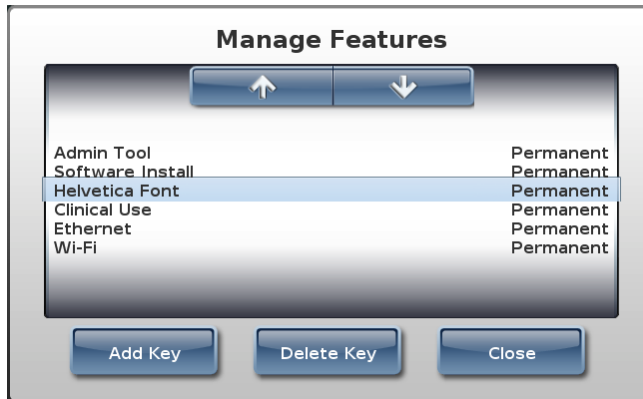

3. Press the **Add Key** button.

The **Add Feature Key** dialog box displays.

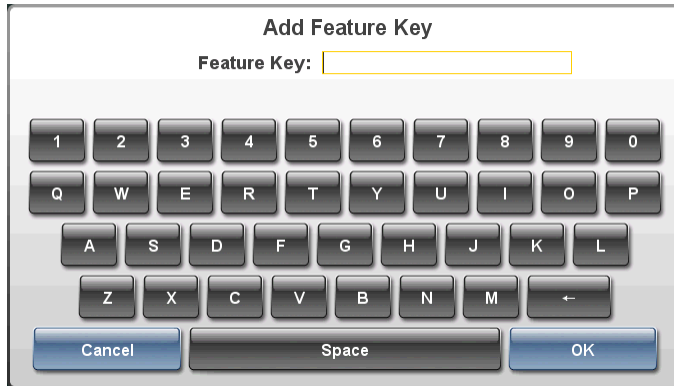

4. Enter the feature key, and then press the **OK** button to install the feature.
You are prompted to confirm the feature installation.

Setting the Date and Time



To set the date and time

1. Press the **Date/Time** button.

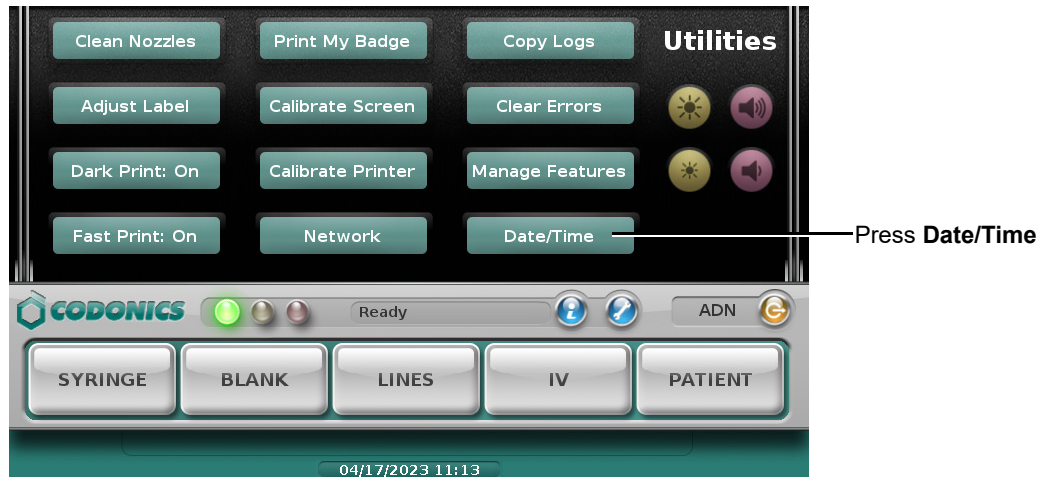

The Set correct date and time screen displays. The **Enable automatic network date and time** setting will be selected or not, depending on how SLS PCS has been configured. If this setting check box is selected, SLS PCS will use the time server to automatically set the date and time and the Date/Time buttons will become unavailable.

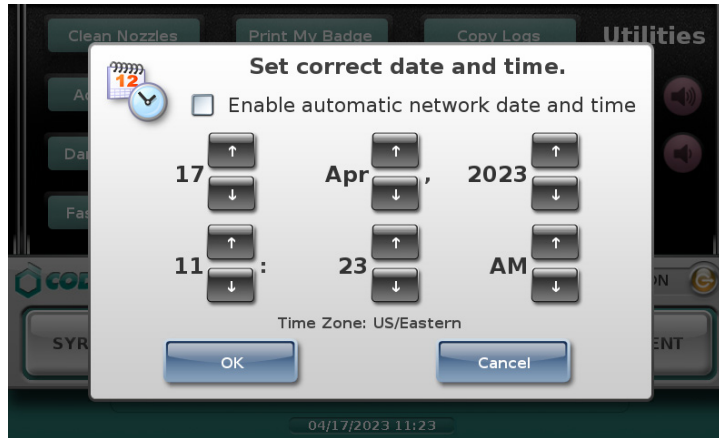

2. If the **Enable automatic network date and time** setting is selected, clear the check box to make the Date/Time buttons available again.

For example, you might have to make the Date/Time buttons available if the time server goes down and the date and time need to be corrected.

3. Use the Date/Time buttons to set the date and time, then press **OK**.



NOTE: When Daylight Savings Time occurs, SLS PCS time will be automatically updated. There will not be a notice of the time change occurring.

Adjusting the Touch Screen Brightness



To adjust the brightness

Press the **Brightness Up** or **Brightness Down** button.



Press **Brightness Up** or **Brightness Down**

The current brightness level is indicated by the brightness level display.

Adjusting the Audio Volume



To adjust the audio volume

Press the **Volume Up** or **Volume Down** button.



Press **Volume Up** or **Volume Down**

The current volume level is indicated by an audible beep and in the volume level display.

If a minimum volume has not been configured for SLS PCS, you can turn the volume down until it is muted. A Muted icon will display in the Dashboard.



Muted icon

Closing the Utilities screen



To close the Utilities screen

Press the **Utilities** button or any area of the dashboard, highlighted in red in the figure below.

Press the **Utilities** button or anywhere in the highlighted area



The Utilities screen closes.

Logging Out



To log out

1. Press the **Logout** button.

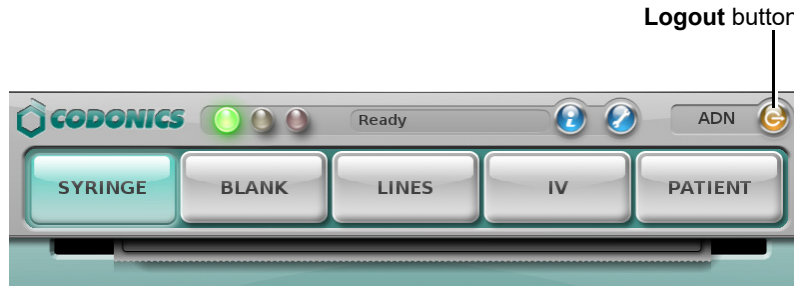

The **Log Out or Shut Down** dialog box displays.

2. Press the **Log Out** button.

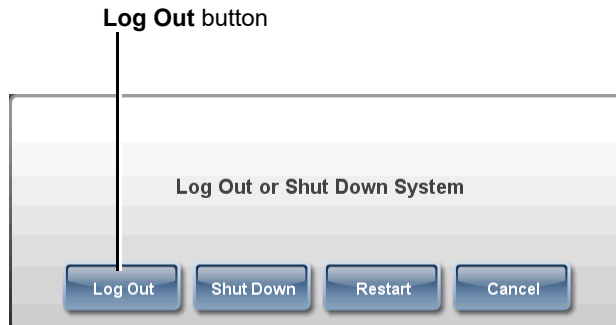

The Login prompt displays.

Being Logged Out Automatically Due to Inactivity

The system includes a preconfigured timeout period (by default, 15 minutes) to help ensure the security of system operations. The timeout period can be up to 18 hours.

If a user is logged in but the user session is idle for the timeout period, a notification message displays and a countdown begins.



To cancel the automatic logout and continue with your session, press the **Continue** button. The system resets the inactivity timer.

Screen Saver On Due to Inactivity

If no users have been logged in for a preconfigured timeout period (60 minutes), the touch screen shows the image below. If you scan a barcode while the screen saver is being shown, the screen saver will be cleared.

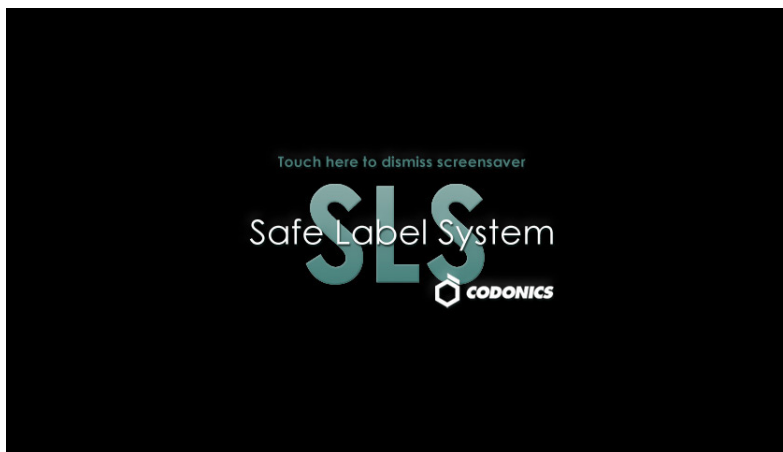

To turn on the display again, press anywhere on the touch screen.

Auto-Logout and Screen Saver in Batch or Copy Mode

When a Batch or Copy Mode job is printing, you will not be automatically logged out nor will the screen saver activate during the following conditions, even if the system is waiting with the OK to Cut message displayed:

- While cutting a strip of labels
- If the end of the media has been reached before the job could be completed

Shutting Down or Restarting the System

You should always shut down the system software before powering down the system.



CAUTION Always make sure that all print jobs have completed before shutting down or restarting the system software:

- Check the Dashboard to ensure that SLS PCS is in Ready mode.
- At the back cover; ensure that the media label roll is not moving.
- At the front cover; ensure that no shaking is occurring.

Shutting Down or Restarting from the Main Screen



To shut down or restart the system software

1. Make sure all print jobs have completed.
2. Press the **Logout** button.



The **Log Out or Shut Down** dialog box displays.



3. Press the **Shut Down** or **Restart** button.

The system shuts down or restarts.

Shutting Down from the Login Prompt



To shut down
the system
software

1. Make sure all print jobs have completed.
2. Press the **Shutdown** button.

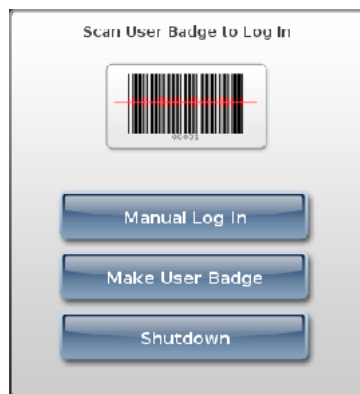

The system shuts down.

Powering Off the System



To power off the system

1. Make sure all print jobs have completed.
2. Shut down the system as described in “Shutting Down or Restarting the System” on page 3-43.

The system shuts down and displays a message indicating that it is now safe to power off the system.

3. Set the Power switch on the rear panel to off.

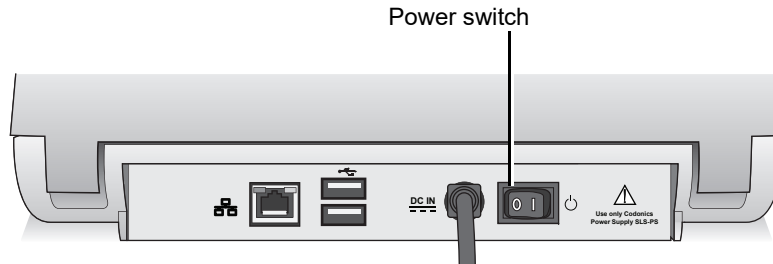

Power switch on the rear panel



CAUTION Always make sure that the user is logged out of the session and all print jobs have completed before shutting down or restarting the system software. Also, always shut down through the user interface so that the ink cartridge is properly capped, the SmartDrive is properly backed up, and the remainder of the system is properly shut down. If SLS PCS is not powered down from the user interface, the following message displays: *Warning Code 86, SLS PCS has recovered from an unexpected shutdown. Use the power icon on the touchscreen for proper shutdown.*

4

Configuring the Network Connection

If SLS PCS is to be connected to a network, then its network settings must be configured. When SLS PCS is properly configured to operate on the network, your SLS administrator can update its formulary and configuration packages remotely, and also monitor its operation.

SLS PCS can connect to the network in one the following ways:

- **Ethernet cable.** For instructions, refer to “Configuring an Ethernet Network Connection” on page 4-3.
- **Enterprise Wi-Fi.** For instructions, refer to “Configuring an Enterprise Wi-Fi Network Connection” on page 4-9.
- **Non-Enterprise Wi-Fi.** For instructions, refer to “Configuring a Non-Enterprise Wi-Fi Network Connection” on page 4-21.

Static SLS PCS Device Names

SLS supports static names for SLS PCSs, which means that a unique fixed IP host name is assigned to SLS PCS via the SmartDrive. This allows SLS PCS to be accessible to the SLS Administration Tool and Email Server if its dynamically assigned IP address changes over time. Having the device name on the SmartDrive allows it to remain the same if SLS PCS is being swapped out.

The device name can be viewed on the **Network** tab of the **System Information** screen in parentheses following the Ethernet IP entry (refer to “Displaying System Information” on page 10-2).

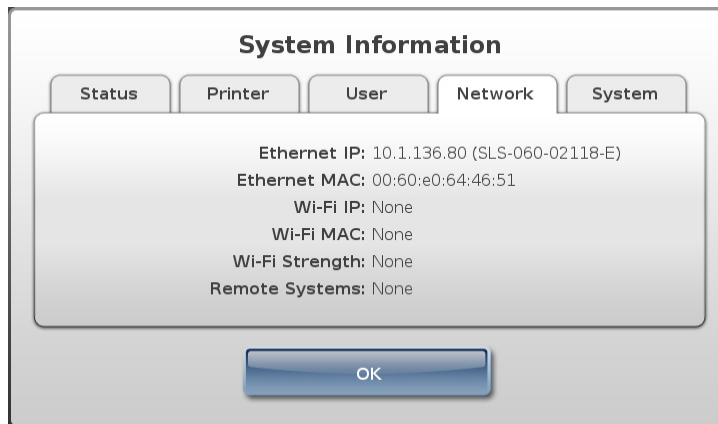

The -E or -W suffixes to the Ethernet IP entry indicate an Ethernet or Wi-Fi connection. The use of static device names can be disabled in the SLS PCS configuration settings, when its configuration is defined using the SLS Administration Tool.

Setting Up Network Hardware

Prior to configuring the network settings, SLS PCS network hardware must be set up.

For more information, refer to “Connecting the Ethernet Cable (Optional)” on page 2-13 or “Connecting the Wi-Fi Adapter (Optional)” on page 2-15.

Configuring an Ethernet Network Connection

By default, SLS PCS Ethernet network connection settings are set to use the DHCP IP address acquisition method. So if the Ethernet cable is connected to a network with a DHCP server, SLS PCS network settings will be automatically populated by the DHCP service and the Ethernet connection will be enabled. No other configuration is required.

However, if you want to use the Static IP address acquisition method, perform the procedure that follows.

Prior to attempting to configure the Ethernet network settings for the Static acquisition method, you should have the IP addresses for the following:

- SLS PCS
- Network mask
- Gateway
- Primary and secondary DNS (optional)



To configure an Ethernet network connection

1. Press the **Utilities** button at the top of the user interface.



The **Utilities** screen displays.

2. Press the **Network** button.

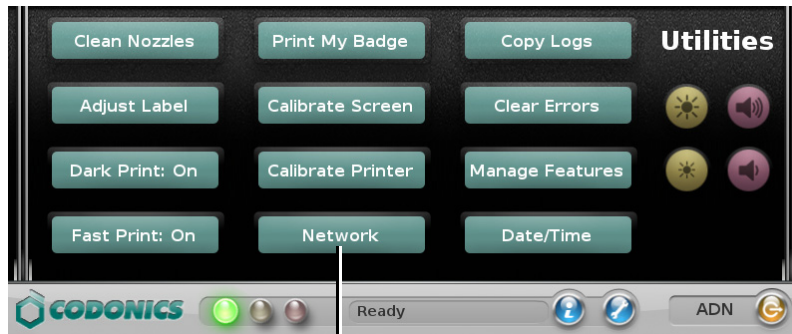

Press Network

The **Network Settings** dialog box displays.

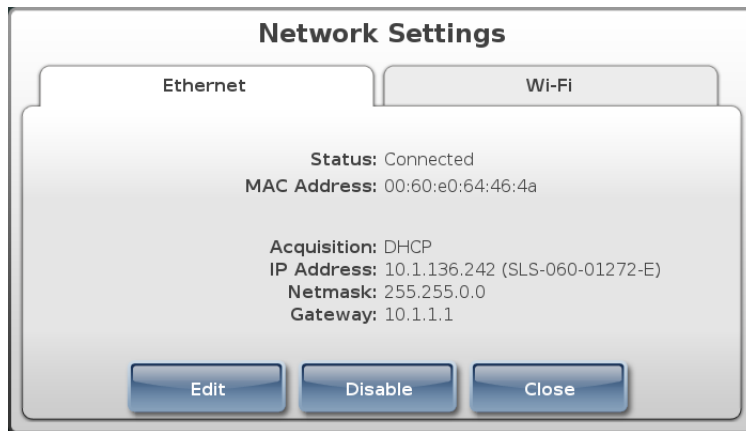

NOTE: For information about the possible network status messages that can be displayed here, refer to "Network Connection Status" on page 4-35.

3. On the **Ethernet** tab, press the **Edit** button.

The **Enter Ethernet Settings** dialog box displays.

Enter Ethernet Settings

Acquisition: **DHCP**

IP Address: 10 . 1 . 130 . 85 Primary DNS: [] . [] . [] . []

Netmask: 255 . 255 . 0 . 0 Secondary DNS: [] . [] . [] . []

Gateway: 10 . 1 . 1 . 1

1 2 3 4 5 6 7 8 9 0

! @ # \$ % ^ & ()

abc ~ - = + * ←

Cancel Alt , . ? Save

4. To change the IP acquisition method, press the **Acquisition** button.

The **Select Acquisition Type** dialog box displays.

Select Acquisition Type

↑ ↓

DHCP
Static

Cancel Select

5. Select the IP acquisition method to be used, then press the **Select** button.
 - If you selected **DHCP**, go to step 7.
 - If you selected **Static**, then you have to enter the network settings on the **Enter Ethernet Settings** dialog box. Go to step 6.
6. Enter the static network settings.

Enter Ethernet Settings

Acquisition: **Static**

IP Address: 10 . 1 . 130 . 91 Primary DNS: [] . [] . [] . []

Netmask: 255 . 255 . 0 . 0 Secondary DNS: [] . [] . [] . []

Gateway: 10 . 1 . 1 . 1

1 2 3 4 5 6 7 8 9 0

! @ # \$ % ^ & ()

abc ~ - _ = + * ←

Cancel Alt , . ? Save

7. When you are finished entering the network settings, press the **Save** button.

The **Ethernet** tab of the **Network Settings** dialog box displays again. If SLS PCS is able to connect to the network with these settings, the status changes to Connected. SLS PCS is now connected to the network.

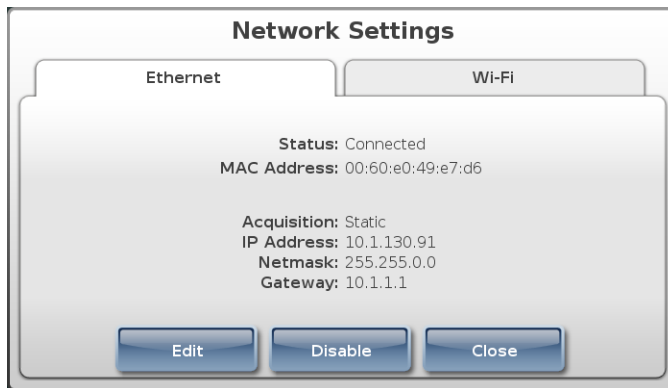

NOTE: If the status is not Connected, refer to “Network Connection Status” on page 4-35 for an explanation of the status, or refer to Table 10-2. Troubleshooting on page 10-10.



NOTE: Once you have saved the network connection settings, wait until SLS PCS has actually connected or failed before editing the settings again. For additional information, refer to “When Network Connection Settings Are Saved” on page 4-37.



NOTE: Record the SLS PCS IP address for the SLS administrator, so that it can be included in the Master Device List for the SLS Administration Tool.

8. Press the **Close** button to close the **Network Settings** dialog box.
9. Press the **Utilities** button to close the **Utilities** screen.

Configuring an Enterprise Wi-Fi Network Connection



NOTE: Wi-Fi support requires a feature key on SLS PCS. Contact your Codonics Sales Representative to obtain the proper key.

If your Enterprise network requires certificates, you must include them in the configuration package installed on SLS PCS must include the SLS PCS Enterprise Wi-Fi certificate files. For instructions on how to include Wi-Fi certificate files in a configuration package and deploy the package to SLS PCSs, refer to Chapter 6 of the *SLS Administration Tool User's Manual*.

If there is a DHCP server on the network, then you perform the following procedure to simply enable the Enterprise Wi-Fi network connection, which is initially disabled by default.

If you want to change the default Enterprise Wi-Fi network connection settings — typically, to change the IP address acquisition method to Static — then you should have the following information ready prior to performing the configuration procedure:

- If using the Static IP address acquisition method, IP addresses for:
 - SLS PCS
 - Network mask
 - Gateway
 - Primary and Secondary DNS (optional)
- SSID (that is, the public name) of the Wi-Fi network that SLS PCS will use
- Wi-Fi security method being used



NOTE: If the network connection is ever switched from an Enterprise to a non-Enterprise Wi-Fi connection and then switched back to an Enterprise Wi-Fi connection, the settings in the Enterprise Wi-Fi certificate files are used again.



To configure an Enterprise Wi-Fi network connection

1. Press the **Utilities** button at the top of the user interface.



The **Utilities** screen displays.

2. Press the **Network** button.

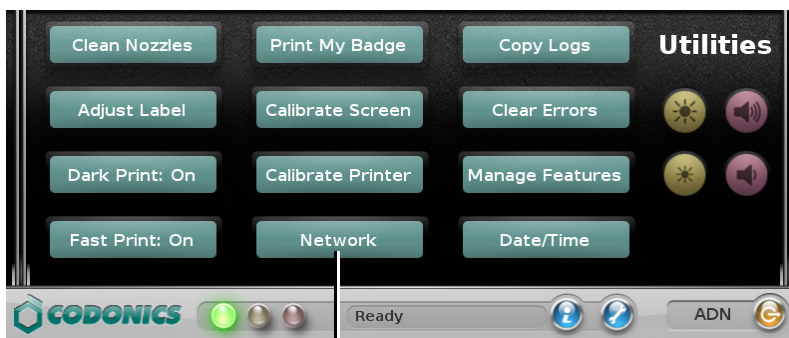

Press **Network**

The **Ethernet** tab of the **Network Settings** dialog box displays.

3. If the **Ethernet** tab shows a **Disable** button, press it to make sure that the Ethernet connection is disabled.

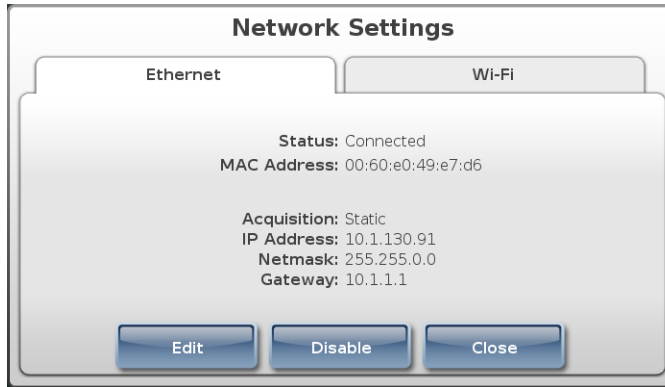

4. Go to the **Wi-Fi** tab.

By default, the Wi-Fi network connection is initially disabled.

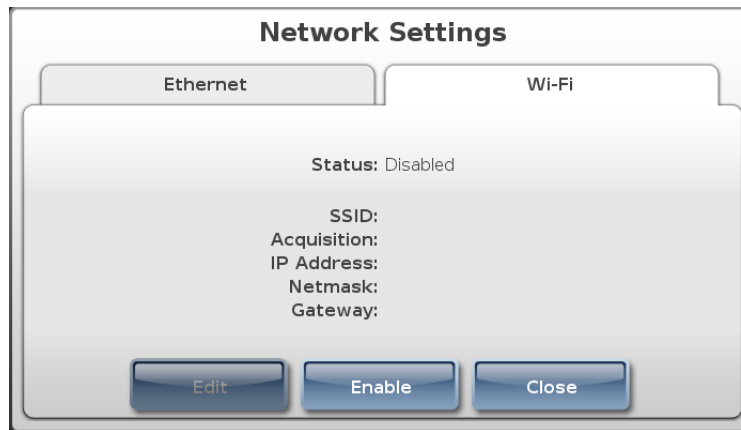

NOTE: For information about the possible network status messages that can be displayed here, refer to “Network Connection Status” on page 4-35.

5. Press the **Enable** button.

If there is a DHCP server on the network and a connection was established, then the status will change to Connected.



No further configuration is required. Go to step 16.

If you need to change the network configuration settings, go to the next step.

6. Press the **Edit** button.

The **Enter Wi-Fi Settings** dialog box displays.

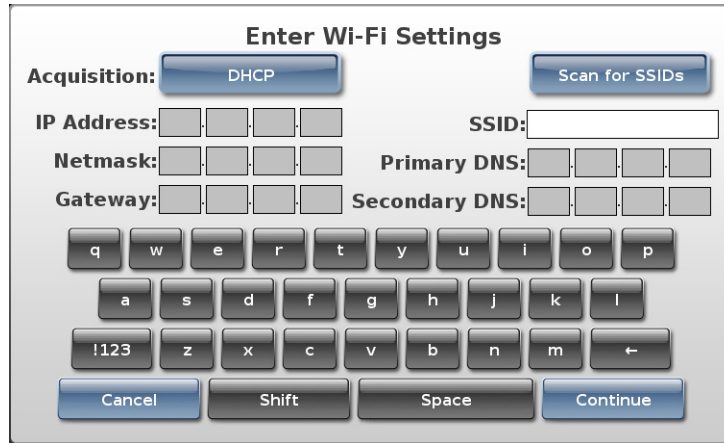

7. To change the IP acquisition method (the default selection is **DHCP**), press the **Acquisition** button.

The **Select Acquisition Type** dialog box displays.

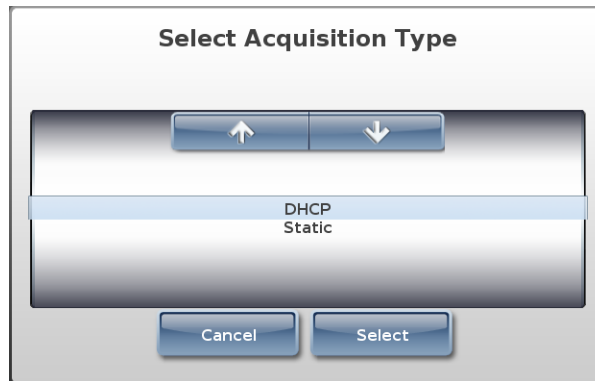

8. Select the IP acquisition method to be used, then press the **Select** button.

The **Enter Wi-Fi Settings** dialog box displays again, showing the IP acquisition method you selected.

Enter Wi-Fi Settings

Acquisition: **Static** Scan for SSIDs

IP Address: [][][][] SSID: []

Netmask: [][][][] Primary DNS: [][][][]

Gateway: [][][][] Secondary DNS: [][][][]

q w e r t y u i o p
a s d f g h j k l
!123 z x c v b n m ←

Cancel Shift Space Continue

9. If using the Static acquisition method, enter the static IP addresses.

Enter Wi-Fi Settings

Acquisition: **Static** Scan for SSIDs

IP Address: 10 1 130 91 SSID: []

Netmask: 255 255 0 0 Primary DNS: [][][][]

Gateway: 10 1 1 1 Secondary DNS: [][][][]

q w e r t y u i o p
a s d f g h j k l
!123 z x c v b n m ←

Cancel Shift Space Continue

10. To enter the Enterprise Wi-Fi network to which to connect SLS PCS:

- Manually enter it in the **SSID** field. Then go to step 12.

or

- Press the **Scan for SSIDs** button. The **Select a Network** dialog box displays.

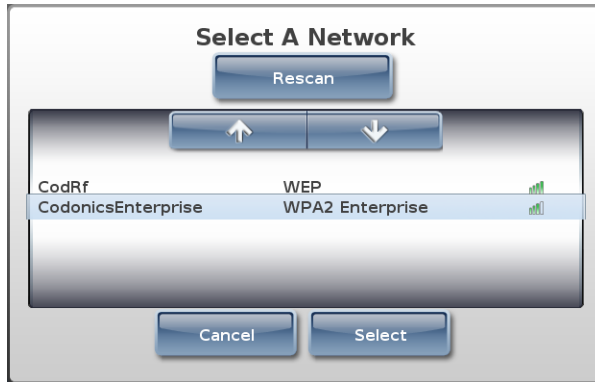

11. Select an Enterprise Wi-Fi network for SLS PCS to join, then press the **Select** button.

The **Enter Wi-Fi Settings** dialog box displays again, with the SSID entered.

Enter Wi-Fi Settings

Acquisition:

IP Address: SSID:

Netmask: Primary DNS:

Gateway: Secondary DNS:

12. Press the **Continue** button.

If you entered the SSID by scanning for it, the **Wi-Fi** tab of the **Network Settings** dialog box displays. Go to step 16.

If you manually entered the SSID, the **Wi-Fi Password Settings** dialog box displays. Go to the next step.

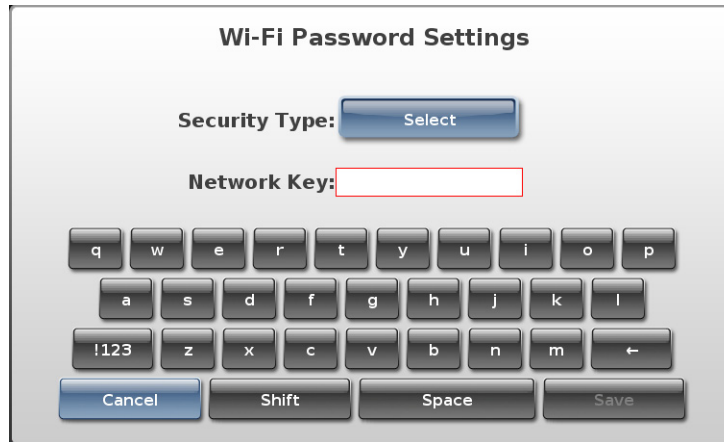

13. Press the **Select** button.

The **Select Security Type** dialog box displays.

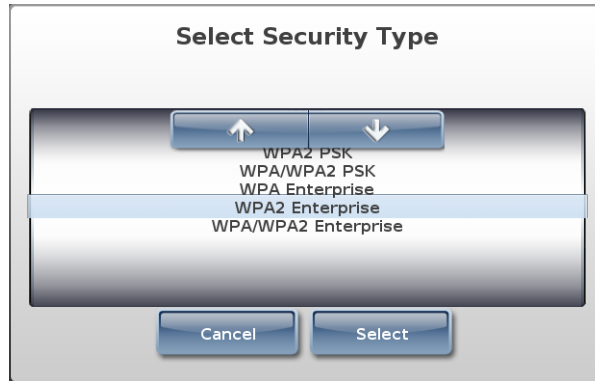

14. Select the appropriate Enterprise Wi-Fi security type setting, and then press the **Select** button.

The **Wi-Fi Password Settings** dialog box displays again. The **Network Password** field is disabled, as the network password in the SLS PCS certificate files is used to access the Enterprise Wi-Fi network.

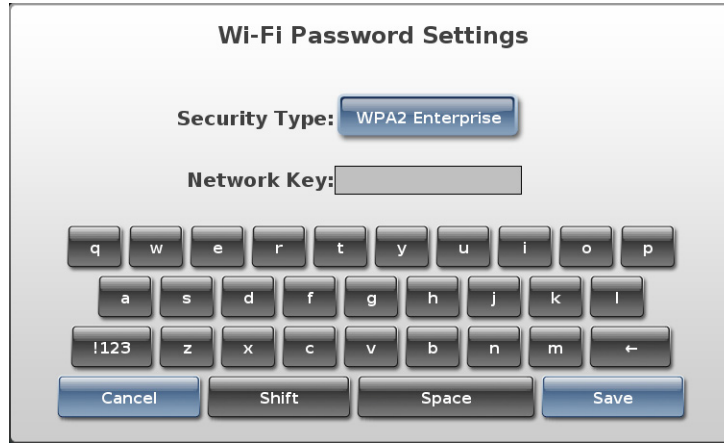

The image shows a dialog box titled "Wi-Fi Password Settings". It has a "Security Type:" label with a dropdown menu set to "WPA2 Enterprise". Below it is a "Network Key:" label followed by a disabled text input field. At the bottom, there is a virtual keyboard with three rows of keys: the first row has q, w, e, r, t, y, u, i, o, p; the second row has a, s, d, f, g, h, j, k, l; the third row has !123, z, x, c, v, b, n, m, and a back arrow. Below the keyboard are four buttons: "Cancel", "Shift", "Space", and "Save".



NOTE: If you press the **Cancel** button on the **Wi-Fi Password Settings** dialog box, all of your previous network setting entries are cleared. They must be entered again to complete the network configuration.

15. Press the **Save** button.

The **Wi-Fi** tab of the **Network Settings** dialog box displays again. If SLS PCS is able to connect to the network with these settings, the status changes to Connected. SLS PCS is now connected to the network.

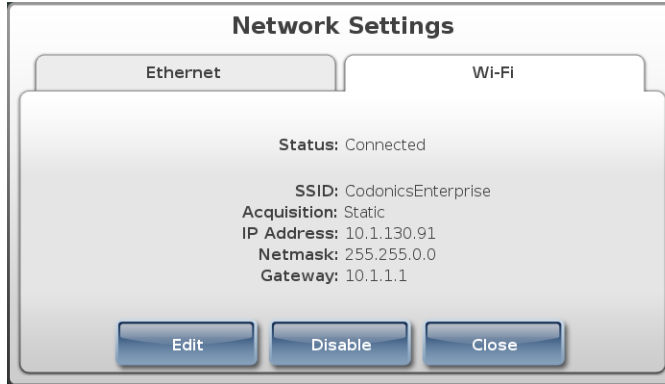

NOTE: If the status is not Connected, refer to “Network Connection Status” on page 4-35 for an explanation of the status, or refer to Table 10-2. Troubleshooting on page 10-10.



NOTE: Once you have saved the network connection settings, wait until SLS PCS has actually connected or failed before editing the settings again. For additional information, refer to “When Network Connection Settings Are Saved” on page 4-37.



NOTE: Record the SLS PCS IP address for the SLS administrator, so that it can be included in the Master Device List for the SLS Administration Tool.

16. Press the **Close** button to close the **Network Settings** dialog box.

17. Press the **Utilities** button to close the **Utilities** screen.

Configuring a Non-Enterprise Wi-Fi Network Connection



NOTE: *Wi-Fi support requires a feature key on SLS PCS. Contact your Codonics Sales Representative to obtain the proper key.*

Prior to attempting to configure the non-Enterprise Wi-Fi network settings, you should have the following information:

- The IP address acquisition method to be used: DHCP or Static
- If using the Static IP address acquisition method, IP addresses for:
 - SLS PCS
 - Network mask
 - Gateway
 - Primary and Secondary DNS (optional)
- SSID (that is, the public name) of the Wi-Fi network that SLS PCS will use
- Wi-Fi security method being used
- Wi-Fi network access password



To configure a non-Enterprise Wi-Fi network connection

1. Press the **Utilities** button at the top of the user interface.



The **Utilities** screen displays.

2. Press the **Network** button.

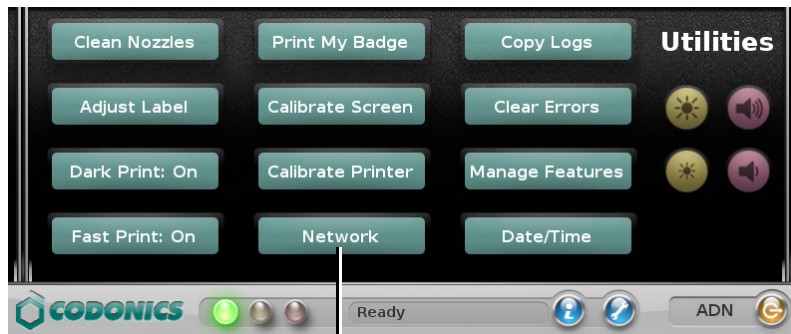

Press Network

The **Ethernet** tab of the **Network Settings** dialog box displays.

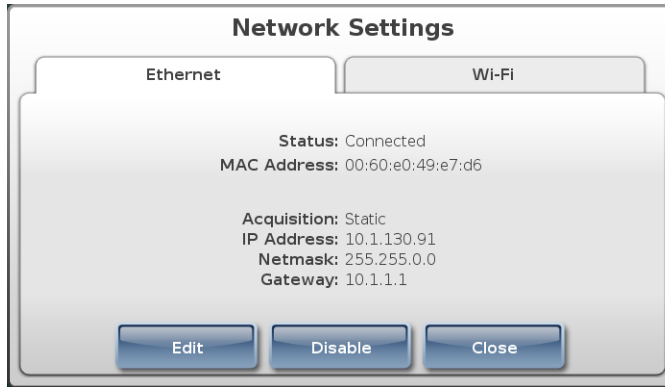

3. If the **Ethernet** tab shows a **Disable** button, press it to make sure that the Ethernet connection is disabled.
4. Go to the **Wi-Fi** tab.

By default, the Wi-Fi network connection is initially disabled.

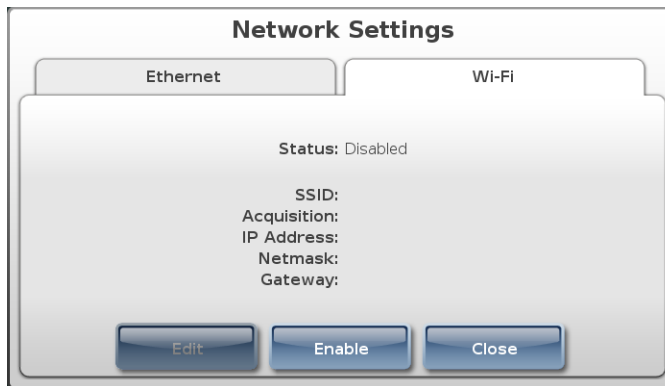



NOTE: For information about the possible network status messages that can be displayed here, refer to “Network Connection Status” on page 4-35.

5. Press the **Enable** button.
6. Press the **Edit** button.

The **Enter Wi-Fi Settings** dialog box displays.

The screenshot shows the "Enter Wi-Fi Settings" dialog box. At the top, the title "Enter Wi-Fi Settings" is centered. Below the title, there are two main sections. The first section contains the "Acquisition:" label followed by a button labeled "DHCP" and a "Scan for SSIDs" button. The second section contains three rows of fields: "IP Address:" with four input boxes, "Netmask:" with four input boxes, and "Gateway:" with four input boxes. To the right of these are "SSID:" with one input box, "Primary DNS:" with four input boxes, and "Secondary DNS:" with four input boxes. Below the fields is a virtual keyboard with keys for letters (q, w, e, r, t, y, u, i, o, p, a, s, d, f, g, h, j, k, l, !123, z, x, c, v, b, n, m, ←) and symbols. At the bottom are four buttons: "Cancel", "Shift", "Space", and "Continue".

7. To change the IP acquisition method (the default selection is **DHCP**), press the **Acquisition** button.

The **Select Acquisition Type** dialog box displays.

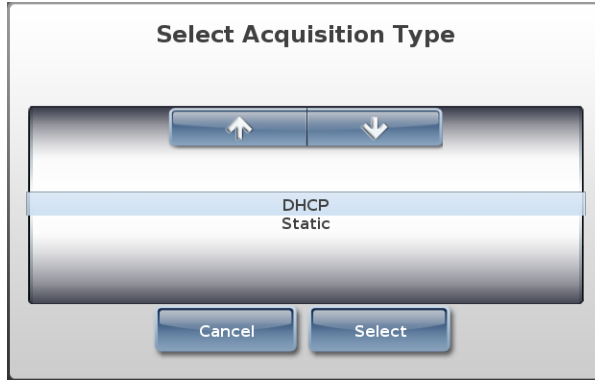

8. Select the IP acquisition method to be used, then press the **Select** button.

The **Enter Wi-Fi Settings** dialog box displays again, showing the IP acquisition method you selected.

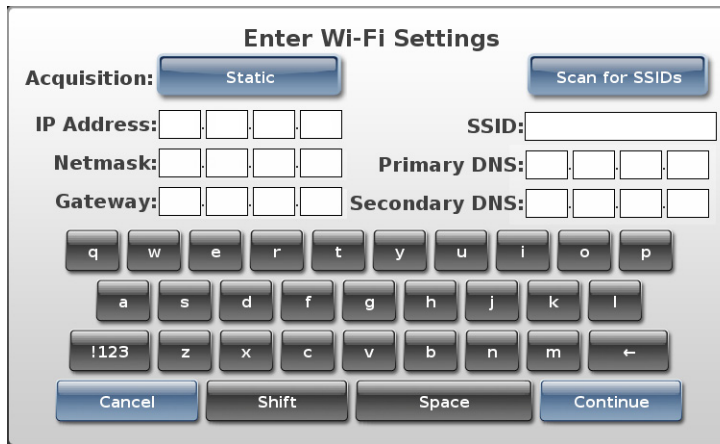

9. If using the Static acquisition method, enter the static IP addresses.

Enter Wi-Fi Settings

Acquisition: **Static** Scan for SSIDs

IP Address: 10 | 1 | 130 | 91 SSID:

Netmask: 255 | 255 | 0 | 0 Primary DNS: | | |

Gateway: 10 | 1 | 1 | 1 Secondary DNS: | | |

q w e r t y u i o p
a s d f g h j k l
!123 z x c v b n m ←
Cancel Shift Space Continue

10. To enter the Wi-Fi network to which to connect SLS PCS:
- Manually enter it in the **SSID** field. Then go to step 12.
 - or
 - Press the **Scan for SSIDs** button. The **Select a Network** dialog box displays.

Select A Network

Scan Again

↑ ↓

CodEnterprise	WPA PSK	📶
CodRf	WEP	📶

Cancel Select

11. Select a non-Enterprise Wi-Fi network for SLS PCS to join, then press the **Select** button.

The **Enter Wi-Fi Settings** dialog box displays again, with the SSID entered.

Enter Wi-Fi Settings

Acquisition:

IP Address: SSID:

Netmask: Primary DNS:

Gateway: Secondary DNS:

q w e r t y u i o p
a s d f g h j k l
!123 z x c v b n m ←

12. Press the **Continue** button.

If you entered the SSID by scanning for it, the Wi-Fi tab of the Network Settings dialog box displays. Go to step 17.

If you manually entered the **SSID**, the **Wi-Fi Password Settings** dialog box displays. Go to the next step.



13. Press the **Select** button.

The **Select Security Type** dialog box displays.

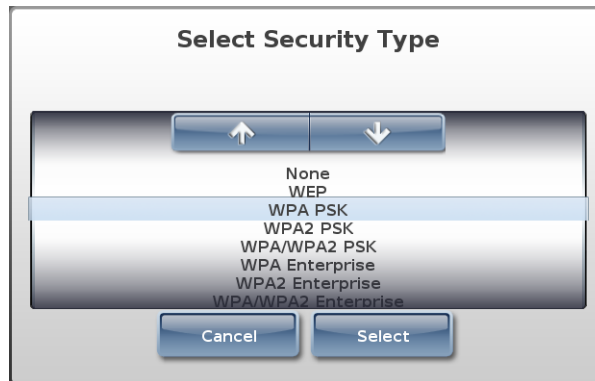

14. Select the appropriate non-Enterprise Wi-Fi security type setting, and then press the **Select** button.



NOTE: If you selected a non-secure network (for example, None or a WEP network), a message displays to notify you of this. WPA or WPA2 is recommended for wireless security because both provide data encryption. WEP is not recommended because security can be breached. Press the **OK** button to dismiss the message.

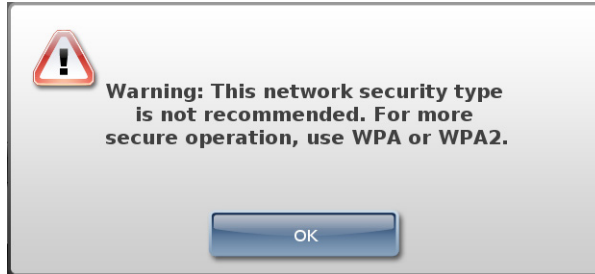

The **Wi-Fi Password Settings** dialog box displays again.

If you selected None for the network security type, go to step 17.

If you selected a network security type that requires a password to access it, go to the next step.

15. In the **Network Key** field, enter the network password.



NOTE: If you press the **Cancel** button on the **Wi-Fi Password Settings** dialog box, all of your previous network setting entries are cleared. They must be entered again to complete the network configuration.

16. Press the **Save** button.

The **Wi-Fi** tab of the **Network Settings** dialog box displays again. If SLS PCS is able to connect to the network with these settings, the status changes to Connected. SLS PCS is now connected to the network.

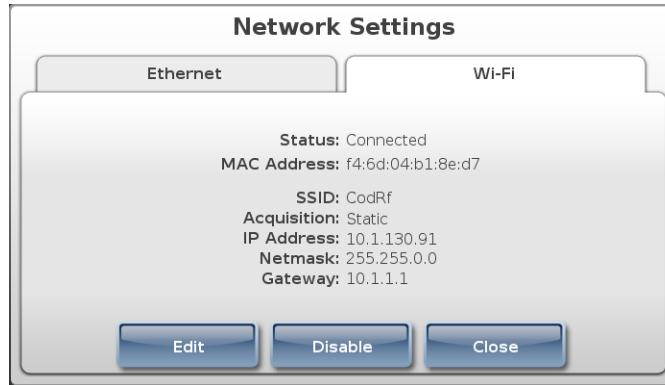

NOTE: If the status is not Connected, refer to “Network Connection Status” on page 4-35 for an explanation of the status, or refer to Table 10-2. Troubleshooting on page 10-10.



NOTE: Once you have saved the network connection settings, wait until SLS PCS has actually connected or failed before editing the settings again. For additional information, refer to “When Network Connection Settings Are Saved” on page 4-37.



NOTE: Record the SLS PCS IP address for the SLS administrator, so that it can be included in the Master Device List for the SLS Administration Tool.

17. Press the **Close** button to close the **Network Settings** dialog box.

18. Press the **Utilities** button to close the **Utilities** screen.

Disabling the Network Connection

You can disable the SLS PCS network connection to take SLS PCS offline from the network.



To disable the
SLS PCS
network
connection

1. Press the **Utilities** button at the top of the user interface.



The Utilities screen displays.

2. Press the **Network** button.

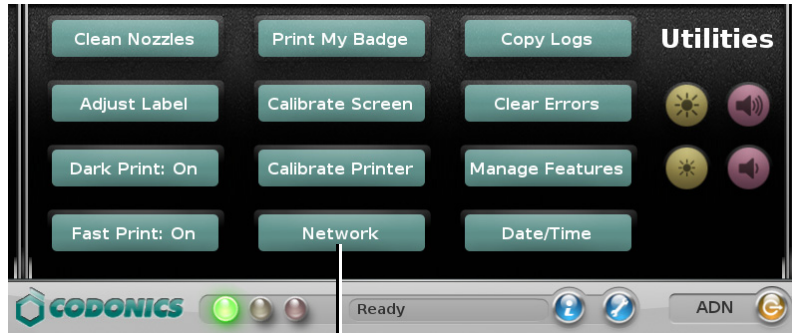

Press **Network**

The **Network Settings** dialog box displays.

3. Go to the appropriate tab.

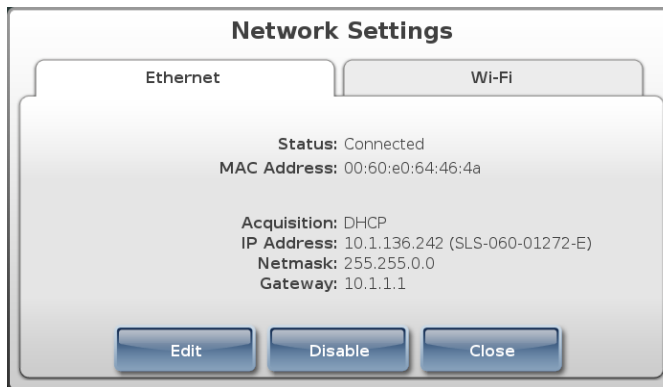

4. Press the **Disable** button.

SLS PCS is taken offline from the network and the status changes to Disabled.

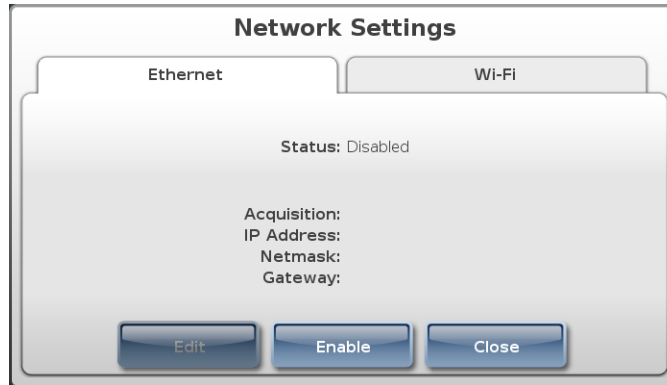

5. To reconnect SLS PCS to the network, reopen the **Network Settings** dialog box and press the **Enable** button.

Network Connection Status

The network connection status of SLS PCS is displayed on the **Ethernet** or **Wi-Fi** tab of the **Network Settings** dialog box.



Table 4-1 describes the network connection status messages that can be displayed here.



CAUTION If the status indicates that the network connection process has not completed (for example, Connecting or Debugging), do not attempt to modify the network connection settings. Wait until the attempted network connection process completes.

Table 4-1. Network Connection Status Messages

Status Message	Description
Associated	SLS PCS is associated the Wi-Fi network for which it is configured.
Associating	SLS PCS is attempting to associate with the Wi-Fi network.

Table 4-1. Network Connection Status Messages (Continued)

Status Message	Description
Connected	SLS PCS is connected to the network for which it is configured. This status indicates completion of a connection attempt.
Connecting	SLS PCS is attempting to connect to the network.
Debugging	SLS PCS is performing Wi-Fi network connection debugging. SLS PCS is writing a log file that might contain helpful information as to why the connection did not occur successfully.
Disabled	SLS PCS network connection has been disabled by an SLS PCS user.
Disabled — Feature Key Missing	The feature key for the network whose tab is being displayed — Ethernet or Wi-Fi — has not been added to SLS PCS.
Disconnected	SLS PCS is not connected to the network, either because the related network settings are not configured or they are not configured correctly. This status indicates that a network connection is not currently being attempted.
Failed	The network connection attempt failed. Either the network password or a network connection setting is incorrect. This status indicates completion of a connection attempt.
Handshaking	Initial communication between SLS PCS and the network is being performed.
Wi-Fi not installed	The Wi-Fi adapter is not installed in the SLS PCS Wi-Fi adapter USB port, or the Wi-Fi adapter is not operating properly.

When Network Connection Settings Are Saved

Ethernet and Wi-Fi network connection settings are only saved when a successful connection occurs.

Once there is a successful connection, selecting the **Edit** button on one of the tabs of the Network utility's **Network Settings** dialog box creates a new network profile that can be edited and that will replace the existing profile on a successful connection.

If you are using Enterprise Wi-Fi certificates, settings from the certificate files are not affected by the network settings configured using the SLS Network utility.

5

Printing Labels

Overview

SLS PCS allows you to scan a drug's barcode and easily print a label containing information about the drug, the preparer, the time of preparation, and other information (for example, concentration, dilution notice, user defined warnings, expiration times), to be affixed to a syringe. It also allows you to print custom labels that have been configured for your site.

Formulary Database

Information about scanned drugs is contained in the formulary database that was installed on SLS PCS. The formulary database is managed by an administrator using the SLS Administration Tool. For more information about the SLS Administration Tool, refer to the *SLS Administration Tool User's Manual*.

Each drug record in the formulary database contains use and labeling information, audio announcements that are played when the drug record is found, whether the dilution should be forced, allowed, or not allowed for the drug, and a choice of concentrations and diluents.

To ensure safety, no changes are ever written to the formulary database in SLS PCS and all formulary updates are handled by a full overwrite of the database.

Container IDs (Outside the USA)

Outside the USA, Container IDs are used to identify drugs. A drug's Container ID is included in its container barcode.

When you scan a drug container to initiate the printing of a syringe label, SLS PCS uses the Container ID to find the correct drug information in the formulary database.

Container IDs and Master IDs (USA Only)

In the USA, 11-digit Master IDs and 10-digit Container IDs are used to identify drugs. A drug's Container ID is included in its container barcode.

Master IDs always uniquely identify a drug. However, in rare cases, the same Container ID could be used for up to three different drugs.

When you scan a drug container barcode to initiate the printing of a syringe label, SLS PCS uses the Container ID to find the correct drug information in the formulary database. SLS PCS looks for drugs with the same Container ID and for Master IDs that map to the Container ID. The Master ID can be used to help locate the correct drug record when the Container ID is not in the formulary database.

Matching Container IDs

Matching is the process that occurs when a drug container barcode is scanned on an SLS PCS and SLS PCS determines that the Container ID in the barcode equals (that is, *matches*) the Container ID for one or more drug records in the formulary database.

Mapping Container IDs to Master IDs (USA Only)

Mapping is the process that occurs when a drug container barcode is scanned and there are 11-digit Master IDs that could potentially map to the scanned 10-digit Container ID.

Learning is the process of associating the 10-digit Container ID with one of the mapped 11-digit Master IDs.

For more information about mapping and learning, refer to “Learning a Drug (USA Only)” on page 5-10.

Verification

Verification is the process of scanning a drug container’s barcode and verifying that the drug name and concentration that is in the formulary database matches the drug name and concentration of the scanned drug container. For more information, refer to “Verifying a Drug” on page 5-12.

Communication of Verification and Drug Not Found Events to the SLS Administration Tool

When a Verification or Drug Not Found (DNF) event occurs, SLS PCS will send the event information via the network to the SLS Administration Tool. An SLS system administrator can then use the SLS Administration Tool to update the existing formulary and distribute a new formulary package to all SLS PCSs. SLS PCS users will then not have to verify the same drug or receive a Drug Not Found message for the drug.

SLS Drug Preparation Methods

There are two preparation methods for managing how drugs are labeled: Normal Dilution and Total Dose/Total Volume (TD/TV).

- **Normal Dilution.** This method is commonly used in OR environments where the amount and frequency of drug administration can vary. Since the total dose being administered might not be known ahead of time, the primary information required on the syringe label is the drug name and prepared concentration.
- **Total Dose/Total Volume (TD/TV).** This method is commonly used when an order or prescription for a drug is issued and the drug is prepared according to the instructions in the order. TD/TV is also used in applications involving infusion pumps. Drugs prepared in this manner include the drug name, the total dose to be administered, and the total volume of the drug and diluent in the final preparation. SLS PCS also includes the equivalent concentration of the preparation on the label for regulatory compliance.

SLS PCS allows multiple TD/TV preparations to be associated with each drug. The preparations are set up using the SLS Administration Tool and included as part of the SLS formulary. When a drug container is scanned on SLS PCS, you can select from TD/TV preparations associated with that drug.

Notes About TD/TV Preparation Method

Note the following about TD/TV preparation method:

- TD/TV information will be printed on labels that support it [for example, 30 x 80-mm Japan labels (JP-L1_vxx)] and shown on any applicable previews.

If the selected drug classification template does not support TD/TV information, the TD/TV dialog boxes described in this manual will still appear on SLS PCS. However, the label will not have any TD/TV information printed on it.

- TD/TV information is not encoded by default in the syringe barcode. A custom barcode that includes this information could be created. Contact Codonics.
- The TD/TV function is only supported for single drugs in the formulary. It is not supported for combination drugs.
- Administer Mode will only announce the drug name and equivalent concentration, but not TD/TV values.

Printing a Syringe Label

The general workflow for printing a syringe label is:

1. If you want to specify the drug's dilution, set the Dilution switch to on.
2. Scan the drug container barcode.
3. Specify the dilution and diluent, if necessary.
4. Confirm the label displayed on the touch screen before printing it, if this confirmation step has been configured.
5. Retrieve the printed syringe label from the output bin.
6. Confirm whether the syringe label printed correctly, if this confirmation step has been configured.

Details for these steps are covered in the following topics.



CAUTION The formulary used on SLS PCS should be one that was created by an SLS system administrator and approved for use.



CAUTION When preparing syringes, always keep control of the drug container and syringe until the label is properly printed, confirmed, and adhered to the proper syringe.



NOTE: It is recommended that syringes smaller than 5 cc (ml) have the printed label wrapped around the barrel of the syringe with the ends adhered together in a flag fashion.

Scanning the Drug Container Barcode



NOTE: You can scan a barcode from any SLS PCS state and it will print a label. You do not have to press the **Syringe** label button.



To scan the drug container barcode

1. To include dilution information on the label for drugs that can be diluted, press the **Dilute** switch to on. This must be done prior to scanning the drug container barcode.



Dilute switch



NOTE: The dilution setting for each drug in the formulary has precedence over the **Dilute** switch setting. Therefore, the **Dilute** switch will be ignored if the drug is not allowed to be diluted or if it is required to be diluted. For more information about determining a drug's dilution setting in the formulary, refer to the SLS Administration Tool User's Manual.



NOTE: The **Dilute** switch is set to off at the completion of the label printing.

2. Scan the drug container barcode by aligning the barcode with the barcode scanner located below the touch screen.



Scanning a barcode on a drug container



NOTE: Place the container below the scanner so that the red cross-hair lines up on the barcode. Placing the container closer to the cover, almost resting it on the cover, instead of placing it closer to the scanner, will also provide better results.

Selecting from Matching Container IDs

Matching is the process that occurs when a drug container barcode is scanned on an SLS PCS and SLS PCS determines that the Container ID in the barcode equals (that is, *matches*) the Container ID for one or more drug records in the formulary database.

For single matches, the matching drug record is automatically selected by the system.

In very rare instances, if more than one match is found, the matching drugs are listed in the **Choose a drug to PRINT** dialog box, as shown below.



NOTE: If there are multiple matches for a Container ID, this dialog box will be displayed every time a drug container barcode with that Container ID is scanned.

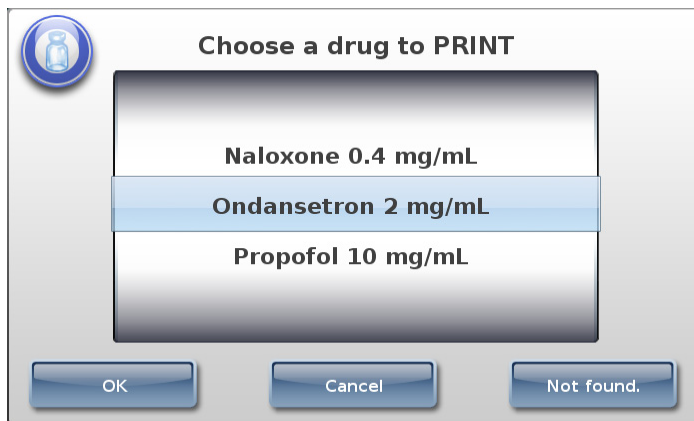

You have three options:

- If none of the choices are correct, press the **Not Found** button. The system indicates that no drugs were selected and a syringe label is not printed.

Or, in the USA, if mappings are then found after pressing the **Not Found** button, then the **Choose a drug to LEARN** dialog box displays. Refer to “Learning a Drug (USA Only)” on page 5-10.

- To cancel the print operation, press the **Cancel** button. The main screen displays.
- If one of the choices is correct, select it and press the **OK** button. A confirmation dialog box displays.

Learning a Drug (USA Only)

Mapping is the process that occurs when a drug container barcode is scanned and there are 11-digit Master IDs that could potentially map to the scanned 10-digit Container ID.

For example, a pharmacist enters only a drug's 11-digit Master ID when adding the drug to the formulary. When a user scans that drug's container barcode for the first time and there are no 10-digit Container ID matches, SLS PCS will look for all 11-digit Master IDs that could potentially map to the drug's Container ID.

Learning is the process of associating the 10-digit Container ID from a scanned drug container barcode with a mapped 11-digit Master ID.

If the Container ID that was scanned can be mapped to more than one Master ID in the formulary database, then any Master ID mappings that are found for the Container ID are displayed in the Choose a drug to LEARN dialog box.

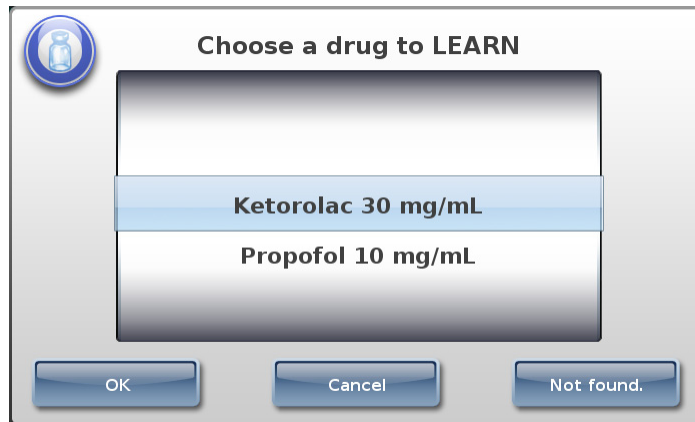

You have three options:

- If none of the choices are correct, press the **Not Found** button. The system indicates that no drugs were selected and a syringe label is not printed. A custom label can then be selected for printing.
- To cancel the print operation, press the **Cancel** button. The main screen displays.
- If one of the choices is correct, select it and press the **OK** button. A confirmation dialog box displays.

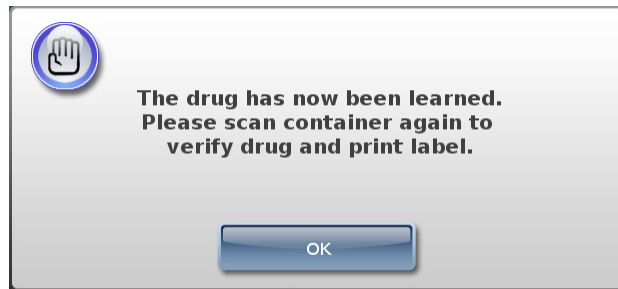

The drug has been learned by the system. The next time this drug container barcode is scanned, the system will remember the correct drug information to use.



CAUTION SLS PCS users can have an SLS PCS learn drug containers. Please contact your SLS system administrator for proper training and usage.



NOTE: Learned drugs are added only to the individual SLS PCS. Global updates should be made in the Master Drug Database (MDD) and formulary using the SLS Administration Tool. For more information, refer to the SLS Administration Tool User's Manual.

Verifying a Drug

Verification is the process of scanning a drug container's barcode and verifying that the drug name and concentration that is in the formulary database match the drug name and concentration of the drug container. By default, each SLS PCS requires that all scanned drug containers be verified the first time that each SLS PCS sees them. Refer to the *SLS Administration Tool User's Manual* for more information about verification configuration.

If a drug's verification status is Not Verified, then the verification prompt displays.

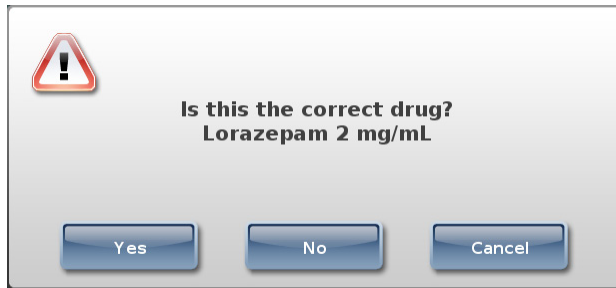

You have three options:

- If the displayed information does not match the drug container, press the No button. The system prompts you to confirm your decision. If you confirm it, then the system indicates that the drug failed verification and you are given the option of printing a custom label. You could then enter the syringe drug information on the custom label by hand. If this drug container barcode is scanned again at this SLS PCS, the system will indicate that the drug has a Verification Failed status and will only allow the option of printing a custom blank label. For more information about custom labels, refer to “Custom Labels” on page 5-40.



CAUTION A failed verification is a serious issue. It means that the formulary is wrong. An SLS system administrator should be consulted immediately to review the logs and correct the formulary.

- To cancel the print operation, press the **Cancel** button. The main screen displays.
- If the displayed information matches the drug container, press the **Yes** button. The system prompts you to confirm your decision.

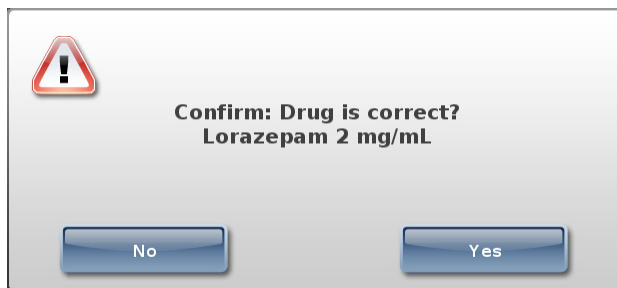

To confirm your decision, press the **Yes** button.



CAUTION SLS PCS users can verify drug containers. Please contact your SLS system administrator for proper training and usage.



NOTE: If a drug record in a formulary is Not Verified, that drug will have to be verified on each of SLS PCSs on which the formulary is installed. Verifying a drug record in one SLS PCS does not change its verification state in the other SLS PCSs.

Drug Not Found (DNF) and Other Item Events

Drug Not Found events occur when a container barcode is scanned and there are no mappings or matches of the NDC in the formulary drug database. To reduce the number of Drug Not Found events, a search algorithm that uses 9-digit matching is executed to identify possible matching drug entries in the formulary.

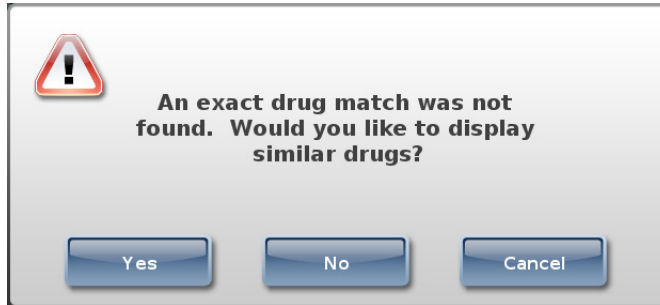

When an SLS PCS user selects a drug entry that was identified by this algorithm, as on the screen shown below, the information is communicated back to the AT Device Manager so that the formulary can be updated and deployed to all SLS PCSs.

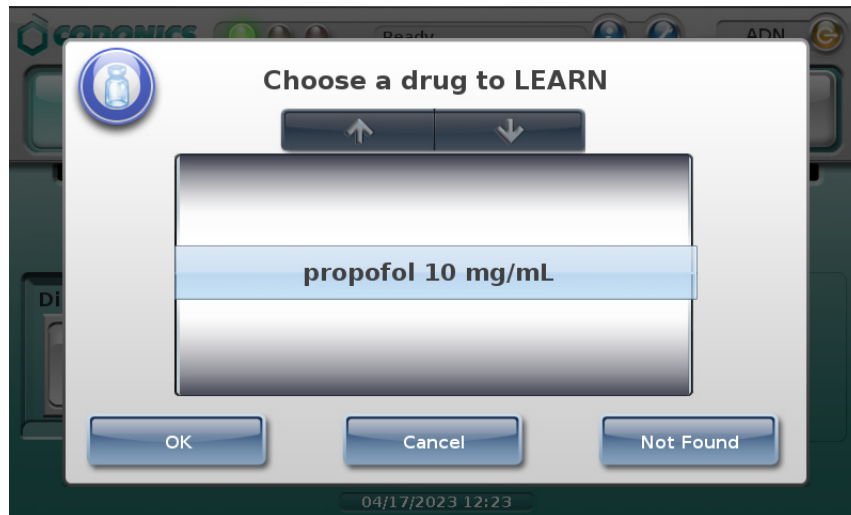

NOTE: Before selecting a possible match, ensure that it is the one you want. The search will display the drug name and concentration and any message associated with that entry. For example, a drug with a message that it is preservative free will have a separate entry shown on the user interface from a drug that is not preservative free and does not have a message.



NOTE: 9-digit matching is enabled using the SLS Administration Tool. Refer to the Version 1.9.0 SLS Administration Tool Release Notes, part number 901-245-014.01.

Other Item events occur when a container barcode is scanned and there is no barcode parsing rule in the formulary drug database.

Drug Not Found and Other Item dialog messages are automatically dismissed after about 7 seconds or when scanning another vial.



Specifying the Dilution and Diluent (Normal Dilution Method)

If you turned the **Dilute** switch on and the drug can be diluted, or if the drug must be diluted, you are prompted to specify the dilution and diluent. When a dilution is required for a drug (e.g., a drug such as Cefazolin that requires reconstitution), SLS PCS announces **Dilution Required** before the drug name and concentration are announced.

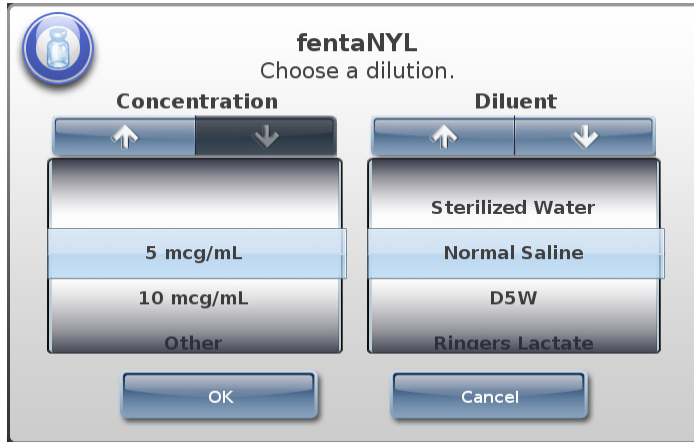

The screenshot shows a software interface for selecting a dilution and diluent for fentaNYL. At the top left is a blue circular icon with a white syringe. The title "fentaNYL" is centered, with the instruction "Choose a dilution." below it. There are two main sections: "Concentration" and "Diluent". Each section has a scrollable list with up and down arrow buttons above it. In the "Concentration" list, "5 mcg/mL" is highlighted with a blue bar. In the "Diluent" list, "Normal Saline" is highlighted with a blue bar. Below the lists are two buttons: "OK" and "Cancel".



NOTE: As of version 2.5.0, the scroll arrows are not available when you can no longer scroll in a specific direction. As shown above, there can be additional options above and below on the visible portion of the wheel list, so make sure to scroll to see all options.



NOTE: As of version 2.5.0, the displayed sort order is numeric (e.g., 1, 2, 3, 10, 20, 30) instead of alphabetic (e.g., 1, 10, 2, 20, 3, 30).

Press and/or drag the lists, or press the up and down arrow buttons, until the appropriate concentration (dilution) and diluent are selected (that is, they are displayed under the blue highlighted bars).

You can also select **Other** for the concentration to print a label with a blank line so that you can enter the dilution on the label by hand. You can also select **Other** for the diluent.



WARNING SLS PCS users are responsible for calculating and selecting the correct concentration and diluent.



NOTE: Additional dilutions can be added using the SLS Administration Tool. For more information, refer to the SLS Administration Tool User's Manual.

After selecting the concentration and diluent, press the **OK** button. One of the following occurs:

- You are prompted to confirm the label before it is printed, if this option has been configured. Go to “Specifying a Total Dose/Total Volume and Diluent (TD/TV Method)” on page 5-19.
- The label is printed. Retrieve the label and go to “Confirming the Printed Syringe Label” on page 5-36.



WARNING To avoid mislabeling syringes, make sure that you immediately remove each label from the output bin after it is printed, confirm the label, and then affix it to the appropriate syringe before attempting to print another syringe label.



WARNING Unwanted labels should be destroyed or disposed of to ensure that incorrect labels are not used.

A Dilution Required message displays on the SLS PCS user interface and is announced when a drug entry is set to Dilution Required in the formulary.



Specifying a Total Dose/Total Volume and Diluent (TD/TV Method)

For drugs in the formulary whose preparation method was specified as TD/TV: If you turned the **Dilute** switch on and the drug can be diluted, or if the drug must be diluted, you are prompted to specify TD/TV and diluent. When dilution is required for a drug (e.g., a drug such as Cefazolin that requires reconstitution), SLS PCS announces **Dilution Required** before the drug name and concentration are announced.

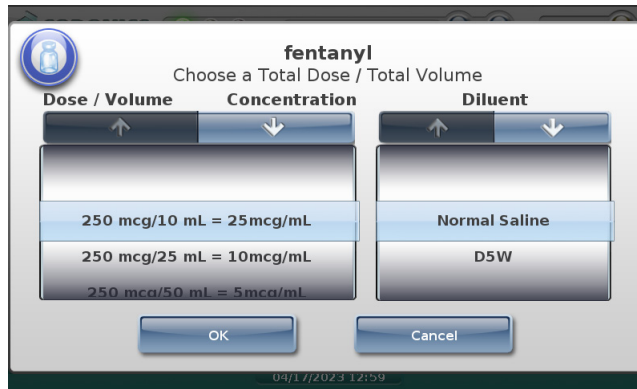

The sort order for TD/TV entries is: TD values are descending (e.g., 10 to 2) and TV values for a given TD value are ascending (e.g., 2 to 10).



WARNING SLS PCS users are responsible for calculating and selecting the correct TD/TV entry and diluent.



NOTE: As of version 2.5.0, the scroll arrows are not available when you can no longer scroll in a specific direction. As shown above, there can be additional options above and below on the visible portion of the wheel list, so make sure to scroll to see all options.



NOTE: As of version 2.5.0, the displayed sort order is numeric (e.g., 1, 2, 3, 10, 20, 30, for ascending) instead of alphabetic (e.g., 1, 10, 2, 20, 3, 30).



NOTE: Additional dilutions can be added using the SLS Administration Tool. For more information, refer to the SLS Administration Tool User's Manual Addendum.



To select TD/TV
and diluent
entries

1. Select the appropriate entries in the lists: press and/or drag the list, or press the up and down arrow buttons, until the appropriate entry is selected (that is, it is displayed under the blue highlighted bars)

In the **Diluent** list:

- If the dilution status for the drug is Not Allowed, the only option in the **Diluent** list will be **None**.
- If the dilution status for the drug is Allowed, a **None** option is included at the bottom of the **Diluent** list.
- If the dilution status for the drug is Required, a **None** option is not included in the **Diluent** list.

2. To save your selections, press the **OK** button.

If you did not select an **Other** TD/TV option, go to step 5.

If you selected an Other TD/TV option, you are prompted to enter the dose and volume values.

Morphine
Enter Other Total Dose/Total Volume

Total Dose
20 mg

Total Volume
2 mL

Equivalent Concentration:
10 mg/mL

OK Cancel

09/17/2023 13:00

3. Enter TD/TV values in the **Total Dose** and **Total Volume** fields.

As you enter the values, the system computes the equivalent concentration and displays it in the **Equivalent Concentration** field.

4. To save the value entries, press the **OK** button.
5. Continue in the label printing workflow:
 - If you are prompted to confirm the label before it is printed, go to “Specifying a Total Dose/Total Volume and Diluent (TD/TV Method)” on page 5-19.
 - If you are not prompted to confirm the label, the label is printed. Retrieve the label and go to “Confirming the Printed Syringe Label” on page 5-36.



WARNING To avoid mislabeling syringes, make sure that you immediately remove each label from the output bin after it is printed, confirm the label, and then affix it to the appropriate syringe before attempting to print another syringe label.



WARNING Unwanted labels should be destroyed or disposed of to ensure that incorrect labels are not used.

The following examples show TD/TV prompt behavior on SLS PCS during the label printing procedure. The examples are based on the drug's Dilution setting and TD/TV entries, as specified in the SLS Administration Tool.

These are examples only; they do not represent an actual drug situation. The examples are intended to represent how TD/TV works and its behavior on SLS PCS.



NOTE: If TD/TV equivalent concentration is within 1% of the original container concentration, the system considers TD/TV to be equivalent to the original concentration. Otherwise, the system considers TD/TV to be a dilution. For example, if the original container concentration is 0.3 g but the TD/TV entry is 0.3333, then they are considered different and 0.3333 is considered a dilution.

TD/TV Prompt Behavior: Example 1

For this example:

- The drug is Morphine.
- The Always Show TD/TV configuration option is on.
- The original drug container concentration is 10 mg/mL.
- The dilution status is set to Allowed.
- The available diluents are Normal Saline, Sterilized Water, and Other.

The configured TD/TV entries include multiples of the original container concentration and dilutions of the original concentration:

- 10 mg/1 mL
- 10 mg/10 mL

- 10 mg/20 mL
- 10 mg/100 mL
- 20 mg/2 mL
- Other mg/mL

The TD/TV prompt will be as follows:

- If the **Dilute** switch is set to **Off**, the TD/TV prompt will display as follows:

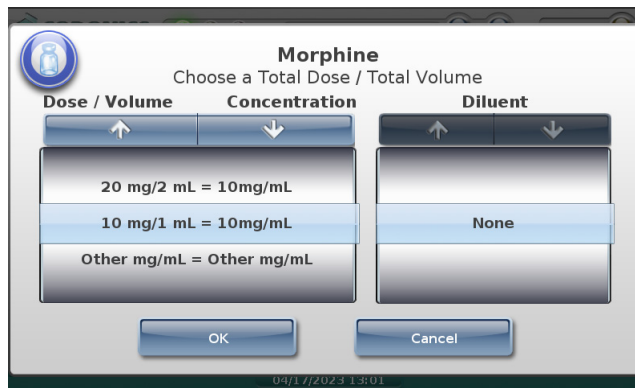

No diluted TD/TV entries or diluents will be shown because the **Dilute** switch is set to off. Only TD/TV entries with concentrations that are equivalent to the original concentration (for example, 10 mg/mL) are displayed and no diluents are displayed.

- If the **Dilute** switch is set to **On**, the TD/TV prompt will display as follows:

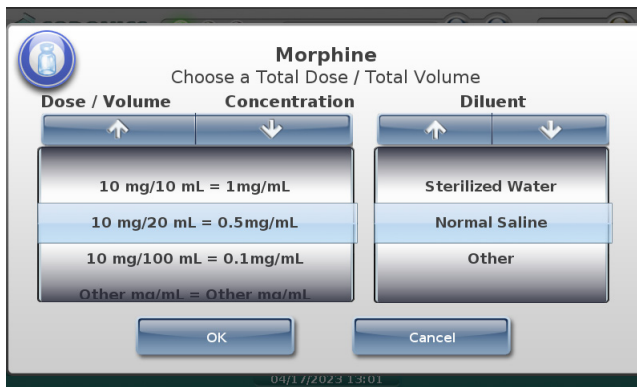

Only TD/TV entries that are dilutions of 10 mg/mL are displayed and the diluents are displayed.

TD/TV Prompt Behavior: Example 2

For this example:

- The drug is Heparin.
- The Always Show TD/TV configuration option is on.
- The original drug container concentration is 10,000 Units/mL.
- The dilution status is set to Not Allowed.
- There are no available diluents.

The configured TD/TV entries include multiples of the original concentration, dilutions of the original concentration, and an Other entry:

- 10,000 Units/1 mL
- 10,000 Units/2 mL
- 20,000 Units/2 mL
- 20,000 Units/4 mL
- 40,000 Units/4 mL
- Other Units/mL

The TD/TV prompt will be as follows:

- If the **Dilute** switch is set to **off**, the TD/TV prompt will display as follows:

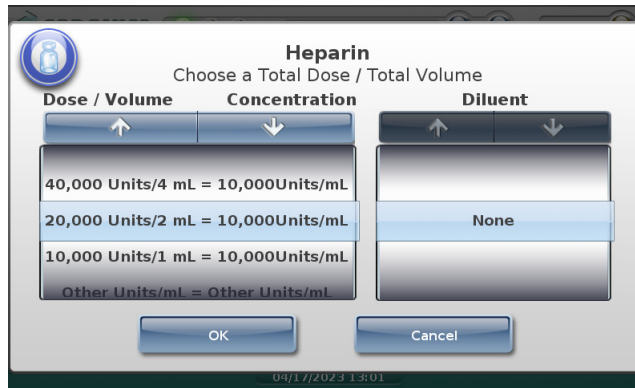

No dilution values of 10,000 Units/mL will be shown. Only TD/TV entries that are equivalent to the original container concentration of 10,000 Units/mL are displayed (for example, 20,000 Units/2 mL), and no diluents are displayed.

- If the **Dilute** switch is set to **on**, the following prompt that indicates that dilutions are not allowed is displayed:

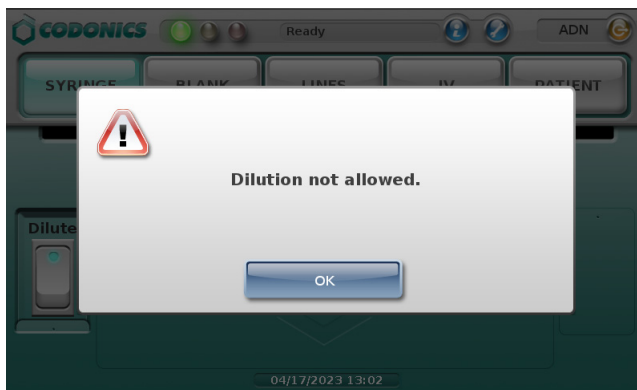

TD/TV Prompt Behavior: Example 3

If the Warning shown in example 2 is ignored and a TD/TV entry is a dilution but the **Dilution** setting is **Not Allowed**, then you will be able to choose a dilution but no diluents will be displayed. You should be aware that this configuration overrides the intention of not allowing dilutions.

TD/TV Prompt Behavior: Example 4

For this example:

- The drug is Atropine.
- The Always Show TD/TV configuration option is on.
- The original drug container concentration is 0.5 mg/mL.
- The dilution status is set to Required.
- The available diluents are Normal Saline and Sterilized Water.

The configured TD/TV entries include multiples of the original container concentration, dilutions of the original concentration, and an Other entry:

- 0.25 mg/10 mL
- 0.5 mg/1 mL
- 0.5 mg/5 mL
- 0.5 mg/10 mL
- 0.5 mg/50 mL
- 1 mg/2 mL
- Other mg/mL

Based on the settings shown above, the following TD/TV prompt displays regardless of whether the **Dilute** switch is set to off or on:

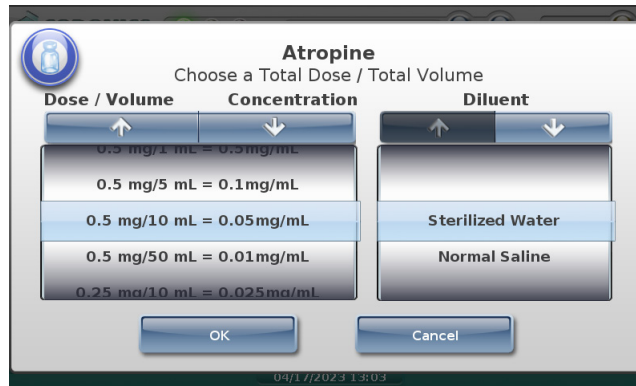

Only TD/TV entries that are dilutions are displayed, and the diluents are displayed.

TD/TV Prompt Behavior: Example 5

For this example:

- The drug is Morphine.
- The Always Show TD/TV configuration option is on.
- The original drug container concentration is 10 mg/mL.
- The dilution status is set to Allowed.
- The available diluents are Normal Saline and Sterilized Water.

The configured TD/TV entries include multiples of the original container concentration, a concentration that is higher than the original concentration, dilutions of the original concentration, and an Other entry:

- 10 mg/1 mL
- 10 mg/10 mL
- 10 mg/20 mL
- 10 mg/100 mL
- 20 mg/1 mL
- Other mg/mL

The TD/TV prompt will be as follows:

- If the **Dilute** switch is set to **off**, and because there is an Other option in the formulary, the drug label will display automatically with the original concentration, ready for printing.

If there were no Other option in the formulary, the TD/TV prompt would display with only TD/TV entries whose concentration are equivalent to the original container concentration.

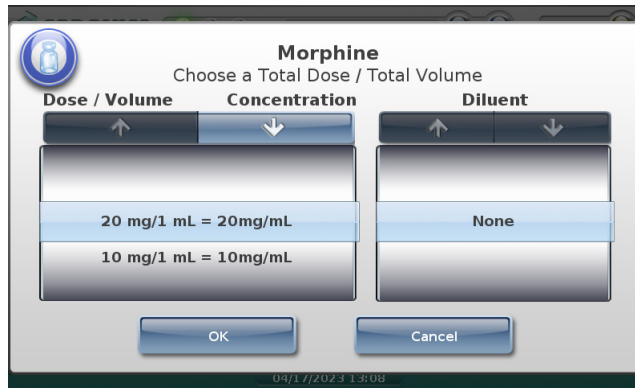

- If the **Dilute** switch is set to **on**, the following prompt that indicates that dilutions are allowed is displayed:

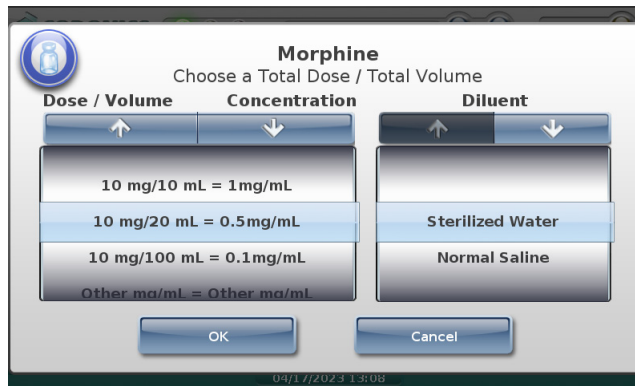



NOTE: If any of the listed concentrations are higher than the original drug concentration, a warning message similar to the following will display in the SLS Administration Tool when creating the formulary to indicate this condition.

Warning: Verify concentration values. The following entries have a concentration that is higher than the original drug concentration

20 mg / 1 ml = 20 mg/ml

Original Drug Concentration = 10 mg/ml

To prevent users from selecting higher concentrations on the SLS PCS, they need to be removed from the formulary using the SLS Administration Tool. For more information about the SLS Administration Tool, refer to the SLS Administration Tool User's Manual.

TD/TV Prompt Behavior: Example 6

For this example:

- The drug is Morphine.
- The Always Show TD/TV configuration option is **not** on.
- The original drug container concentration is 10 mg/mL.
- The dilution status is set to Allowed.
- The available diluents are Normal Saline, Sterilized Water, and Other.

The configured TD/TV entries include a concentration that is equivalent to the original container concentration and a dilution:

- 10 mg/1 mL
- 10 mg/10 mL

The TD/TV prompt will be as follows:

- If the **Dilute** switch is set to **off**, the TD/TV entry whose concentration is equivalent to the original container concentration will be automatically selected because it is the only non-diluted concentration defined for the drug. A TD/TV prompt is not displayed.
- If the **Dilute** switch is set to **on**, the TD/TV prompt will display as follows:

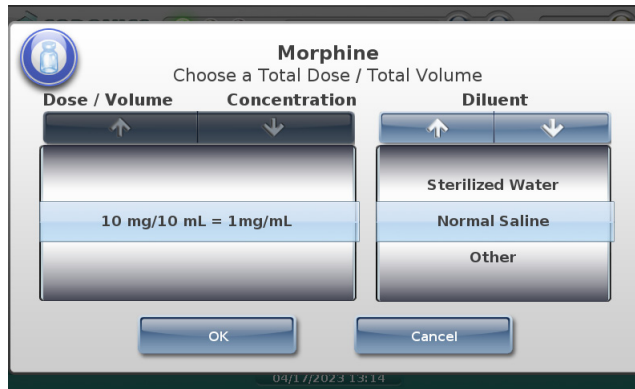

The prompt is displayed because, even though there is only one dilution value, multiple diluents have been selected for the drug. If only one diluent had been selected, then the dilution and diluent would have been automatically selected by the system and no prompt would have been displayed.

TD/TV Prompt Behavior: Example 7

For this example:

- The drug is Morphine.
- The Always Show TD/TV configuration option is on.
- The original drug container concentration is 10 mg/mL.
- The dilution status is set to Allowed.
- The available diluents are Normal Saline and Sterilized Water.

The only configured TD/TV entry is Other mg/mL.

The TD/TV prompt will be as follows:

- If the **Dilute** switch is set to **off**, only the Other entry will be displayed in the TD/TV prompt:

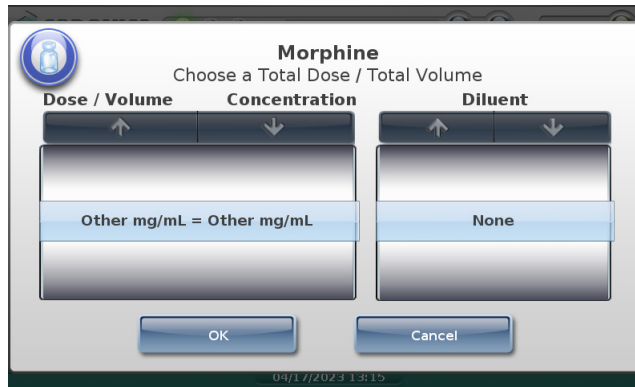

- If the **Dilute** switch is set to **on** and you select a TD/TV entry whose concentration is equivalent to the original container concentration (for example, 20 mg/2 mL), the system will display the following message to indicate that the entered TD/TV might not be a dilution:

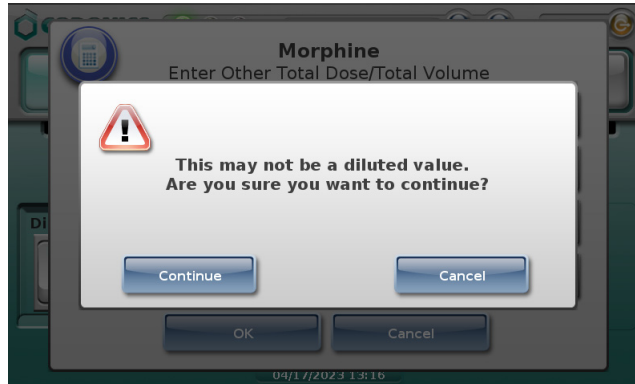

Confirming the Syringe Label Before Printing It

If the system is configured to require visual confirmation of the label before printing it, you are prompted to confirm the displayed label.



NOTE: If a sound file has been configured for the scanned drug, the system also announces the drug name and, if specified, the concentration when the label to be printed is displayed on the main screen.



NOTE: Labels as presented on the touch screen and in print form might not be an absolute match to how your SLS system administrator viewed them in the SLS Administration Tool.

If the label is not correct or you do not want to print the label at this time, press the **Cancel** button.



CAUTION A failed visual label confirmation is a serious issue. It might mean that the formulary is wrong. An SLS system administrator should be consulted immediately to review the logs and correct the formulary.

If the label is correct, press the **Print** button to confirm it and print the label. After the label has been printed, retrieve it from the output bin.



WARNING To avoid mislabeling syringes, make sure that you immediately remove each label from the output bin after it is printed, confirm the label, and then affix it to the appropriate syringe before attempting to print another syringe label.



WARNING Unwanted labels should be destroyed or disposed of to ensure that incorrect labels are not used.

Next you need to confirm that the label printed correctly. Go to “Confirming the Printed Syringe Label” below.

Confirming the Printed Syringe Label

If the system is configured to require confirmation after printing the syringe label, you are prompted to scan the label's barcode to confirm that it printed correctly.



NOTE: Labels as presented on the touch screen and in print form might not be an absolute match to how your SLS system administrator viewed them in the SLS Administration Tool.

After reviewing the printed label and the label displayed on the touch screen, you have the following options:

- Scan the label's barcode.
 - If the barcode is correct, the system plays an audible beep, briefly displays a confirmation message, and then displays the main screen.

- If the scanned barcode is incorrect, the system displays a message explaining the actions that can be taken.



WARNING Incorrect syringe labels should be destroyed or disposed of to ensure that they are not used.



CAUTION A failed label content confirmation is a serious issue. It might mean that the formulary is wrong. An SLS system administrator should be consulted immediately to review the logs and correct the formulary.

- If by visual inspection you can see that the label did not print correctly, press the **No** button. You are prompted to indicate whether there was a label content error or a problem printing the label.



After pressing either of the **Error** buttons, the system displays a message explaining the appropriate action to take.



WARNING Incorrect syringe labels should be destroyed or disposed of to ensure that they are not used.



WARNING If the barcode scan or you indicate that the label content was not correct or that the label was not printed correctly, contact the SLS system administrator or Codonics Technical Support (+1 440.243.1198) to resolve the problem before attempting to print a syringe label again.



CAUTION A failed label content confirmation is a serious issue. It might mean that the formulary is wrong. An SLS system administrator should be consulted immediately to review the logs and correct the formulary.

- If you are unable to scan the barcode, press the **Unable to Scan** button. You are prompted to discard the label and to try scanning the drug container barcode and printing the label again. Correct the scanning problem before attempting to print any more labels.



WARNING Unconfirmed syringe labels should be destroyed or disposed of to ensure that they are not used.

Auxiliary Barcodes for Container IDs

SLS PCS supports auxiliary barcodes on standard-size labels so that a 1D barcode of the Container ID of the original drug container can be included on printed labels.

Auxiliary barcodes can contain:

- A 10-digit Container ID when the SLS Master Drug Database (MDD) mode is set to US NDC.
- A 10- or 13-digit Container ID when the SLS MDD mode is set to Other.

Only the original Container ID of the drug container will be encoded in the auxiliary barcode.



WARNING Scanning the auxiliary barcode in Administer Mode or when the SLS PCS main screen is displayed will create another label. If creating this label was unintended, either cancel the label's printing at the pre-print confirmation screen or discard the label.

Printing a Placeholder Graphic for a Non-Compliant Container ID

If SLS PCS detects that a drug's Container ID is not compliant with the 10-digit or 13-digit limit, it will print a label with a special **X** graphic, as shown in the example below.

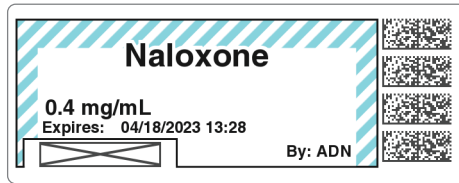

For example, the last digit of a 13-digit Container ID must be a check digit for the rest of the Container ID. If it is not, then the Container ID will be non-compliant.

SLS PCS will not display any error or warning messages when non-compliant Container IDs are encountered. The placeholder graphic will act as the only indicator that the drug Container ID is not compatible with the auxiliary barcode.

Manually Entering the Expiration Date/Time on a Syringe Label

If the drug's expiration time has been set to 0 in the formulary, the syringe label will include a blank space for you to manually enter the expiration date/time.

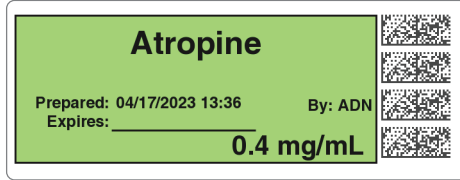

Custom Labels

In addition to printing syringe labels, SLS PCS can print custom labels that are configured for your site.

The next topic describes the custom label categories. For instructions about how to print custom labels, refer to “Printing Custom Labels” on page 5-45.

Custom Label Categories

By default, the system includes pre-defined categories for Blank, Lines, I.V., and Patient labels. These categories are described in the following topics.



NOTE: Custom labels can be added using the SLS Administration Tool. For more information, refer to the SLS Administration Tool User's Manual.

Blank

These blank syringe labels (no drug name or concentration) are provided for the labeling of drugs that do not have an NDC barcode on them, are not in the formulary, or cannot be read by the barcode scanner. By default, one copy of the Blank label will be printed when it is selected.

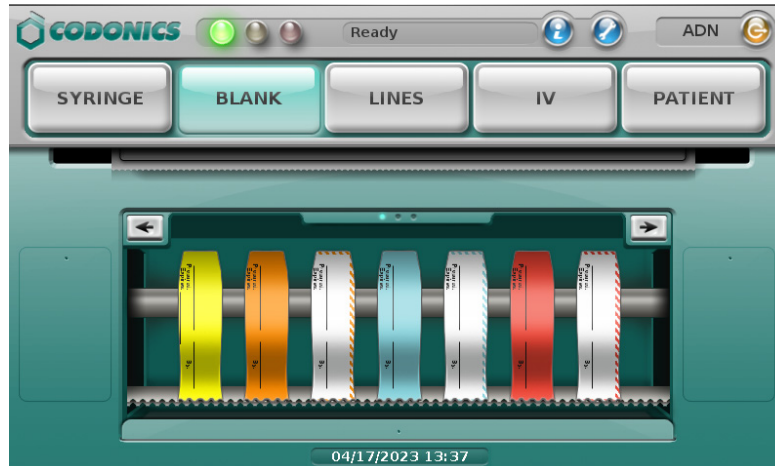

Lines

These labels are provided for the labeling of invasive monitoring lines used commonly in anesthesia. By default, one copy of the Lines label will be printed when it is selected.

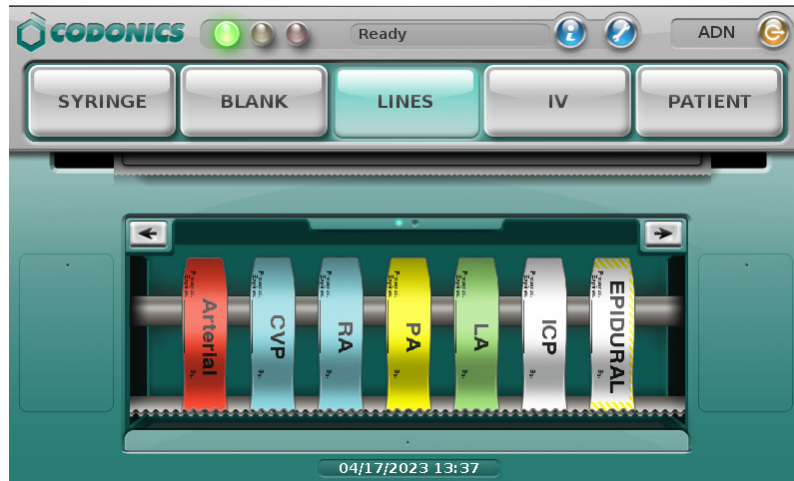

IV

These labels are provided for the labeling of the general IV line and catheter. By default, two copies of the IV label will be printed when it is selected.

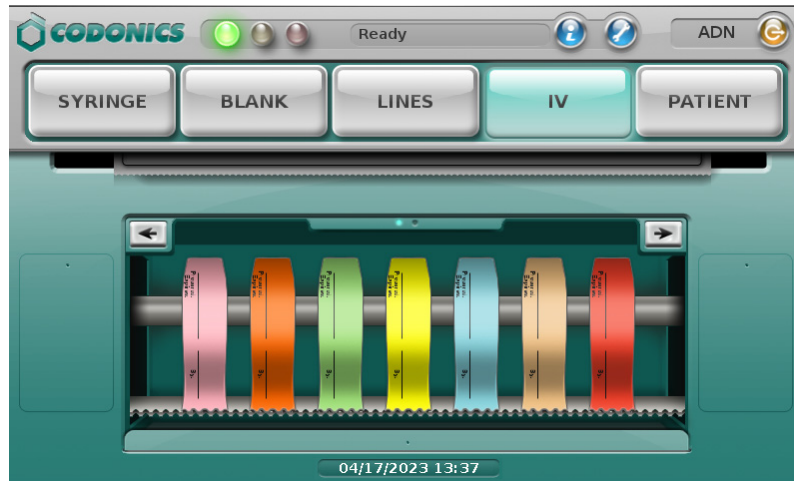

Patient

These labels are provided for the labeling of the reports and specimens. By default, two copies of the Patient label will be printed when it is selected.

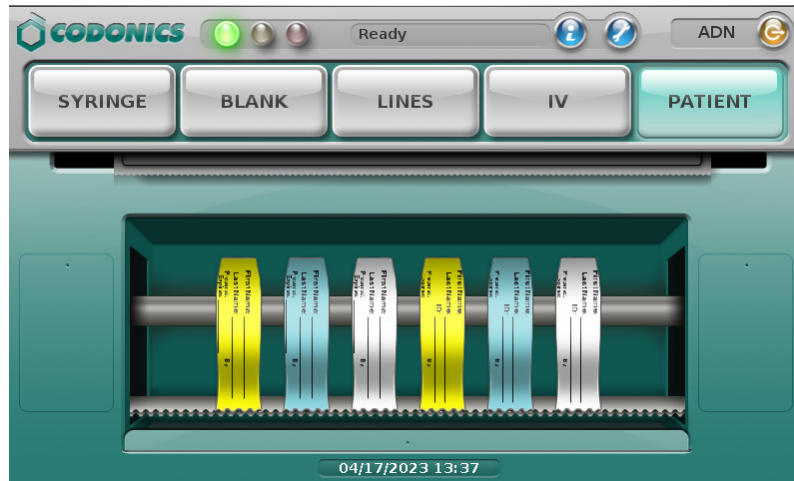

Printing Custom Labels



To print a custom label

1. Press one of the custom label buttons.

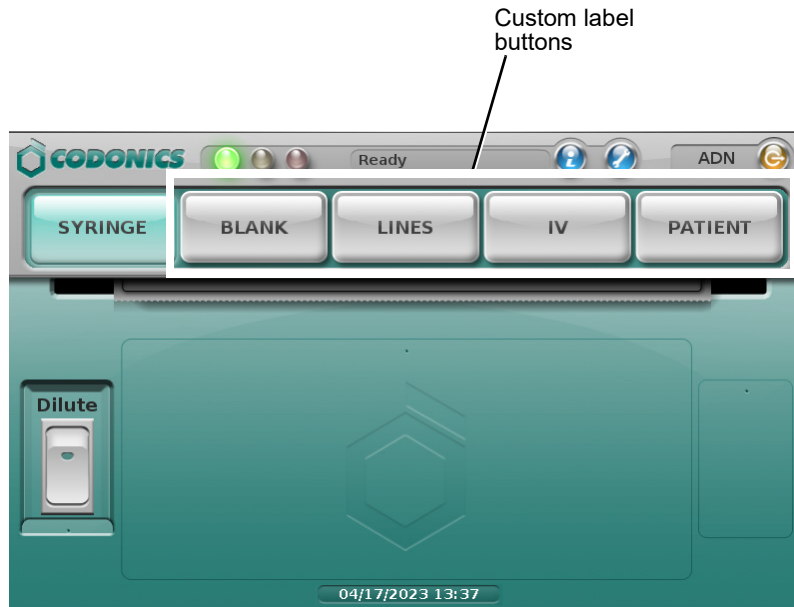

The system displays a selection of the custom labels that are available for that category.

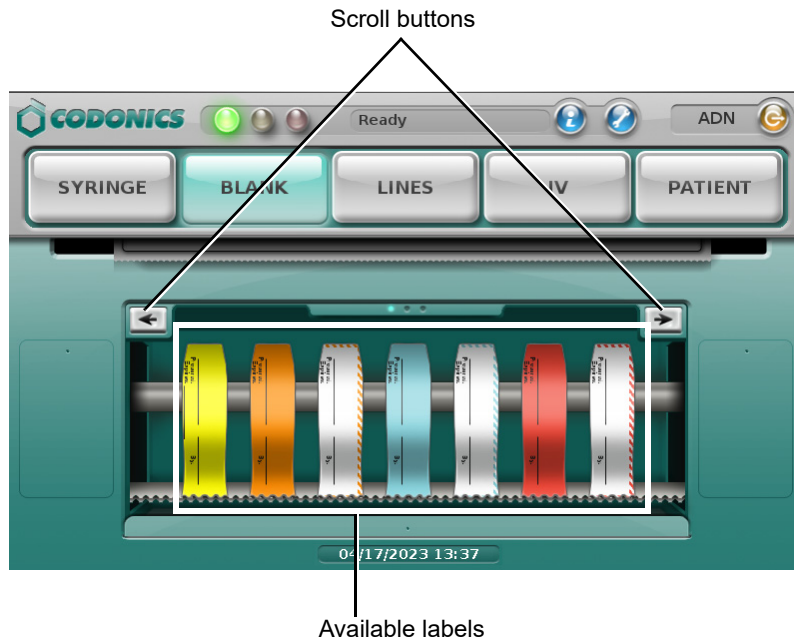

2. If there are more custom labels than can be displayed at one time, press the left or right arrow buttons to scroll to the other labels.
3. Press the desired custom label to print it.

The system prints the label. There is no pre-print or post-print confirmation of custom labels.

Printing Labels in Batch Mode



WARNING The safest way to label a syringe (or any container of medication) using SLS PCS is to scan a drug container, draw up the drug as the label is being printed, and then immediately label the syringe before setting it down. Batch Mode introduces the risk of a mislabeled syringe since more than one label from a single container scan is being created. This changes the one-to-one relationship (e.g., one vial and one syringe with a single label). For example, if there is more than one filled syringe without a label, there is a potential for a syringe to be mislabeled. Or if there are more labels than there are filled syringes, there is a potential for an extra label being placed on the wrong syringe. Be sure to visually confirm that the label you are applying is the correct one for the syringe being labeled.



NOTE: Batch Mode requires a feature key on SLS PCS. Contact your Codonics Sales Representative to obtain the proper key.



NOTE: Batch Mode is configured using the SLS Administration Tool. Refer to the Codonics SLS Batch and Copy Modes Technical Brief (901-268-003).

In a typical Pharmacy application, Batch Mode allows you to automatically print multiple copies of the original label. The label can include a user-defined lot number and a larger initial area for use cases in which two sets of initials are required on the label. This might occur because a different person prepared the label than prepared the syringe, or if an additional safety check is required.

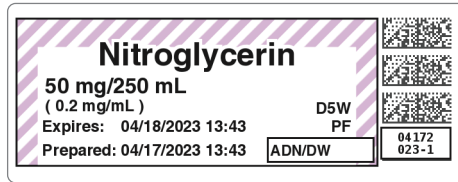

Positioning SLS PCS to Support Printing Labels in Batch Mode

To avoid issues when printing labels in Batch Mode:

- Make sure that SLS PCS is placed on a flat surface. If SLS PCS is rotated toward its right side, the hanging strip of labels can cause strain during printing. This in turn can cause labels to be vertically misaligned and ink to be printed on the liner instead of the label.
- Place the rear edge of SLS PCS flush with the edge of the desk or table on which it is positioned. This will allow the printed strip of labels to hang over the edge freely while printing.

Printing Multiple Labels in Batch Mode

1. Make sure that the media is fed properly into the media path.

If the media is not fed in straight, the printed information on the label could be printed onto the liner.



To print multiple
labels in Batch
Mode

2. Make sure that the label contents are properly centered on printed labels.

Print 10 to 20 labels to make sure that the print location has stabilized. Then, if needed, use the Adjust Label utility to adjust the media path to center the label contents properly on the labels. Refer to “Adjusting the Media Path” on page 3-18.

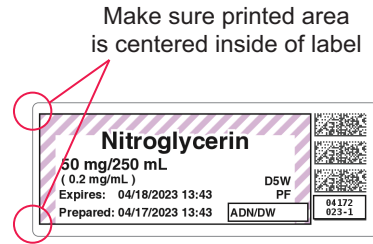

3. Press the **Batch** button.



The **Batch Mode Configuration** screen displays.

4. Enter the number of copies of the label to print and, if applicable, a second preparer's initials and a lot number.

Batch Mode Configuration

Copies: Second Preparer's Initials:

Lot Number:

Single Strip

- 1 2 3
4 5 6
/ 7 8 9
: ABC 0 ←

Cancel OK

- Up to 999 copies can be printed in one batch job.
 - A lot number can be up to 18 alphanumeric characters.
 - If a lot number is entered, the bottom barcode will be replaced with the human-readable lot number. If a lot number is not entered, then the bottom barcode on the label will print normally with a barcode. See an example of a label with the lot number in step 7.
 - If a lot number is entered that was previously used, an alert message will display letting you know that it was already used.
 - The number of copies and the lot number entries will not persist from batch job to batch job.
5. Select whether to cut the labels:
 - **Single:** Cut in between each copy of the label
 - **Strip:** Leave all copies of the labels on a single liner.

The selection of **Single** or **Strip** will persist from batch job to batch job.



NOTE: If *Strip* is chosen, you will be asked at the end of the batch whether to cut the liner.

6. To save your entries, press **OK**.
7. Scan the container barcode.

The label displays. If entered, it includes:

- The second preparer's initials in the box with your initials.
- The lot number in the bottom barcode area.

Also, the number of copies to be printed displays on the **Batch** icon.



Once printing has started, the number of labels that have been printed is displayed in the system status box.

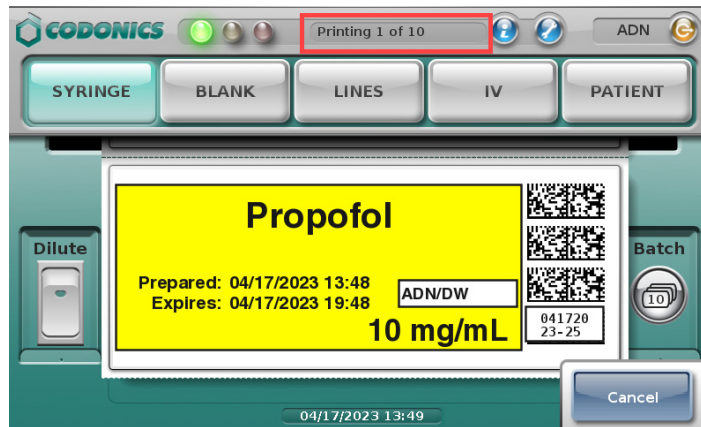

NOTE: To cancel the printing of the batch job, press the Cancel button on the main screen. The job will be stopped once the current label is finished printing.

When the batch is completed, if **Strip** was selected on the **Batch Mode Configuration** screen, a screen displays that shows the job status and prompts you to confirm cutting the liner.



8. Press OK.

The dialog box closes and the liner is cut.



WARNING Handling of long strips of labels increases the chance of a paper cut.



CAUTION Do not pull the strip of labels or try to tear the strip of labels. This can cause jamming and/or damage to SLS PCS.



NOTE: If SLS PCS is configured for Post Print Confirmation, the Post Print Confirmation screen displays after the batch is complete. You will need to scan only the last label to confirm the printed labels.



NOTE: If printing a one-color label in Batch Mode (e.g., yellow for Propofol), an ink cartridge is considered unusable if the single color is empty, even if a predominant amount of the two other colors (e.g., cyan or magenta) remain in the cartridge. This is to make sure that all potential colors (e.g., green) can be produced with the cartridge.

Reaching the End of Media Before a Batch or Copy Job Completes

Strip Cut Printing

When using strip cut printing, if the end of the media is reached before printing in Batch or Copy Mode is completed, a message displays that indicates how many labels of the total number have printed and that the system is out of labels.



After pressing **OK**, the printed labels are cut and the media is automatically rewound. The following message displays.

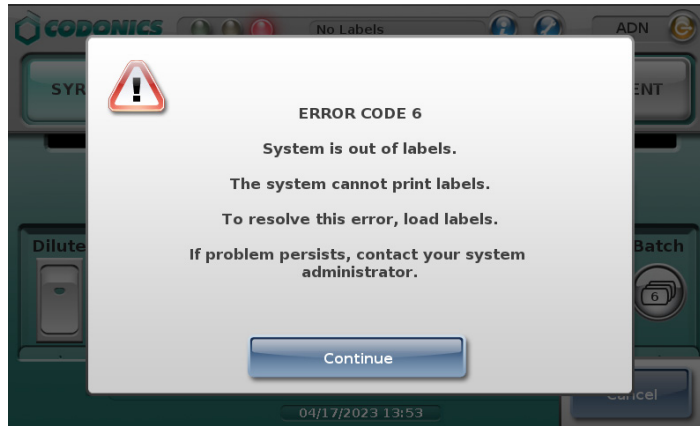

Replace the media (refer to “Loading or Replacing the Label Media” on page 2-26 and press **Continue** to dismiss the message. The batch or copy job will be completed.

Single Cut Printing

If you print in Batch Mode using single cuts, when the last available label prints, SLS PCS will cut the last label and then automatically rewind the media. A message will appear indicating the system is out of labels and to load a new roll of labels. If the batch job was not completed, once a new roll of media is loaded, the job will complete.

Printing Labels in Copy Mode

Copy Mode allows you to print multiple copies of the same label from a single scan of a drug container. For example, three copies of a label might be required from a single scan of a Phenylephrine vial if the same label is being used on a 100-mL IV bag, a syringe drawn from the IV bag, and the line coming from the IV bag.



WARNING The safest way to label a syringe (or any container of medication) using SLS PCS is to scan a drug container, draw up the drug as the label is being printed, and then immediately label the syringe before setting it down. Copy Mode introduces the risk of a mislabeled syringe since more than one label from a single container scan is being created. This changes the one-to-one relationship (e.g. one vial and one syringe with a single label). For example, if there is more than one filled syringe without a label, there is a potential for a syringe to be mislabeled. Or if there are more labels than there are filled syringes, there is a potential for an extra label being placed on the wrong syringe. Be sure to visually confirm that the label you are applying is the correct one for the syringe being labeled.



NOTE: Copy Mode requires a feature key on SLS PCS. Contact your Codonics Sales Representative to obtain the proper key.



NOTE: Copy Mode is configured using the SLS Administration Tool. Refer to the Codonics SLS Batch and Copy Modes Technical Brief (901-268-003).



To print multiple copies of a label from a single scan

1. Make sure that the media is fed properly into the media path.

If the media is not fed in straight, the printed information on the label could be printed onto the liner.

2. Make sure that the label contents are properly centered on printed labels.

Print 10 to 20 labels to make sure that the print location has stabilized. Then, if needed, use the Adjust Label utility to adjust the media path to center the label contents properly on the labels. Refer to “Adjusting the Media Path” on page 3-18.

Make sure printed area
is centered inside of label

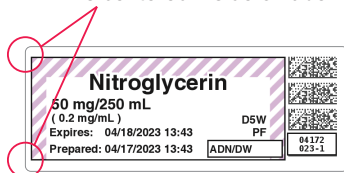

3. To turn on Copy Mode, press the Copy switch.



NOTE: If the drug entry in the formulary is set to Required for Copy Mode, you do not need to press the Copy switch. When you scan the drug container, the Copy dialog box shown in step 4 will automatically appear.



NOTE: If you need to dilute the drug and make copies, you should press both the Dilute switch and the Copy switch. You will first be prompted to select the dilution information and then enter the copy information.

4. Scan the container's barcode.

If the drug is set in the formulary to Allowed or Required for Copy Mode, the **Copies** screen displays.

5. Enter the required number of copies, from 1 to 9.

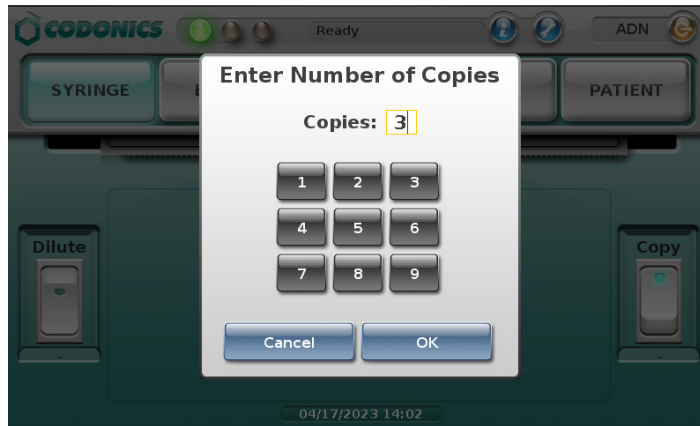

6. Press **OK**.

Once printing has started, the number of labels that have been printed is displayed in the system status box.

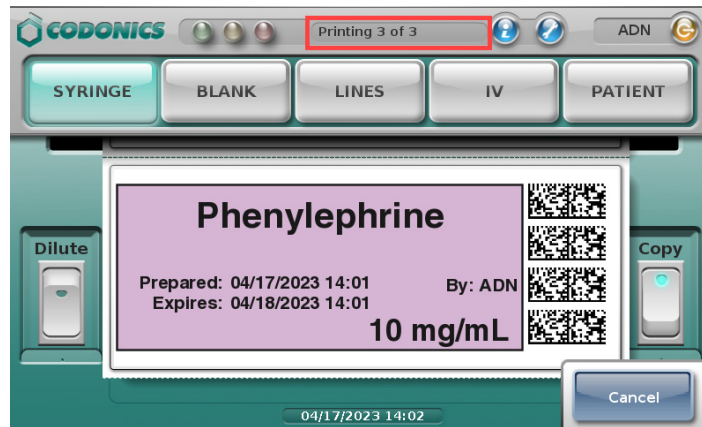

NOTE: To cancel the printing of the copy job, press the Cancel button on the main screen. The job will be stopped once the current label is finished printing.

When the printing is completed, a screen displays that shows the job status and prompts you to confirm cutting the liner.



7. Press OK.

The dialog box closes and the liner is cut.



WARNING Handling of long strips of labels increases the chance of a paper cut.



CAUTION Do not pull the strip of labels or try to tear the strip of labels. This can cause jamming and/or damage to SLS PCS.



NOTE: If SLS PCS is configured for Post Print Confirmation, the Post Print Confirmation screen displays after the printing is complete. You will need to scan only the last label to confirm the printed labels.

If the end of the media is reached before printing in Copy Mode is completed, a message displays indicating that the system is out of labels. For more information, refer to “Reaching the End of Media Before a Batch or Copy Job Completes” on page 5-53.

SLS Advanced Smart Scanning

SLS Advanced Smart Scanning (SASS) is an optional feature that allows you to scan a container and print a label, not print a label, or allow printing of an SLS label. For example, you can scan a prefilled syringe and only hear SLS PCS announce the drug name and concentration without printing a label. This better ensures that you have selected the correct drug when there is no need for a printed label.

When integrated with a drug cart that supports SASS, this feature also decrements inventory of those items scanned on SLS PCS. For example, it allows you to scan non-drug containers (e.g., gauze, syringes) that have barcodes on their packaging and not print an SLS label but still automatically decrement the cart inventory.



NOTE: SASS requires a feature key on SLS PCS. Contact your Codonics Sales Representative to obtain the proper key.

SASS Use Cases

Following are use cases when scanning drug containers with SASS enabled.



NOTE: When a drug cart supports SASS and is integrated with SLS PCS, the cart will also support Common Login/Common Scan.



NOTE: When a drug cart is not integrated with SLS PCS, the following use cases will not perform any inventory accounting. SLS PCS behavior will still be as defined in the use case.

SLS Formulary Drug Print Setting Set to Always

SLS PCS will display the drug label with all predefined elements shown (e.g., label template, drug name, concentration, preparation/expiration time, etc.), announce the drug name and concentration, and print the label. The cart will automatically decrement the inventory as long as the drug is in the cart's formulary.

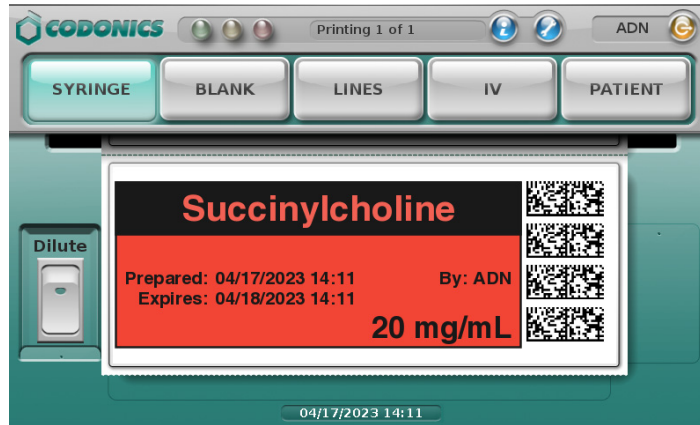

SLS Formulary Drug Print Setting Set to Never (e.g., Pre-Filled Syringe)

SLS PCS will display the drug label with all predefined elements shown, announce the drug name and concentration, but **not** print the label. After a few seconds, the label will automatically close. The cart will automatically decrement the inventory as long as the container is in the cart's formulary.



NOTE: Scanning another container while the message is displayed will also dismiss the message.

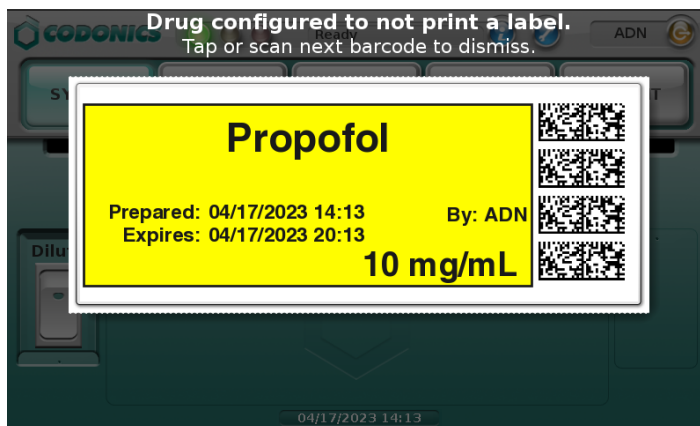

SLS Formulary Drug Print Setting Set to Allow (e.g., Pre-Filled Syringe)

SLS PCS will display a label with all predefined elements shown, announce the drug name and concentration, and allow you to print the label or dismiss it. The cart will automatically decrement the inventory as long as the container is in the cart's formulary.



NOTE: Scanning another container while the message is displayed will also dismiss the message.



Drug Container Not Found in the SLS Formulary

SLS PCS displays a Drug Not Found message and announces **Drug Not Found**. After a few seconds the message will automatically close. The cart will automatically decrement the inventory as long as the container is in the cart's formulary.



Drug Container Not Found in the SLS Formulary but Stocked in the Cart (e.g., Gauze, Syringes)

SLS PCS displays an Other Item message. After a few seconds the message will automatically close. The cart will automatically decrement the inventory as long as the container is in the cart's formulary.



NOTE: Scanning another container while the dialog is displayed will also dismiss the dialog.



6

Administer Mode

Administer Mode provides an additional safety check by scanning the SLS syringe label barcode as shown below prior to administering a drug to:

- Confirm the drug indicated on the syringe label with an audible announcement and a visual display of the drug name and concentration on the main screen.
- Determine whether the drug in the syringe has passed its expiration date.



NOTE: Administer Mode requires a feature key on SLS PCS. Contact your Codonics Sales Representative to obtain the proper key. Administer Mode also requires configuration of the supported primary barcode definition.



To scan the syringe barcode

Align the syringe barcode with the barcode scanner located below the touch screen.

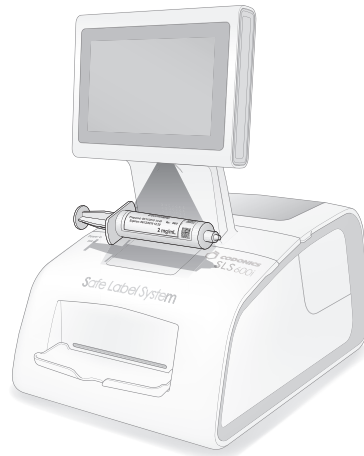

Scanning a barcode on a syringe



NOTE: Place the syringe below the scanner so that the red cross-hair lines up on the barcode. Placing the syringe closer to the cover, almost resting it on the cover, instead of placing it closer to the scanner, will also provide better results.

The drug information or other status from the scan is displayed and spoken.

The following topics describe the possible responses from SLS PCS. Messages that do not have a button on them will close after a few seconds. You can also press this type of message to dismiss it.

Drug Is Found in the Formulary, Has Not Expired

If the drug is found in the SLS formulary and it has not expired, SLS PCS announces the drug name and concentration. Both are also displayed with the amount of time remaining before the drug will expire.



Drug Is Found in the Formulary, Has Expired

If the drug is found in the SLS formulary but its expiration date has passed, SLS PCS announces that the drug is expired and then announces the drug name and concentration. This information is also displayed.

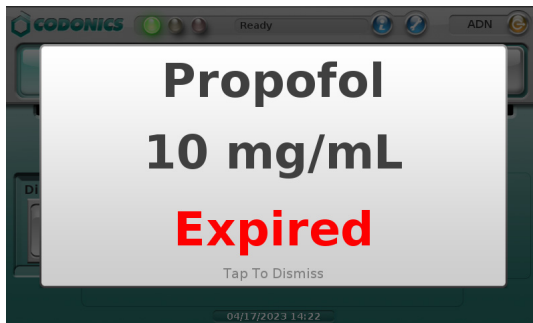

Drug Is Found in the Formulary, Requires Concentration Confirmation

If the drug is found in the SLS formulary but requires that the concentration must be confirmed, SLS PCS announces the drug name and that the concentration has to be confirmed. This information is also displayed.

If a unique concentration (e.g., Other) is used for the drug or an audio file for the concentration is not available, SLS PCS announces “Confirm Concentration” only.



Drug Is Not Found in the Formulary

If the drug is not found in the SLS formulary, a Drug Not Found message is displayed.



CAUTION Not finding the drug in the formulary is a serious issue. It means that the formulary is different than the one that was used to create the syringe label. Contact an SLS system administrator immediately to review the logs and correct the formulary.

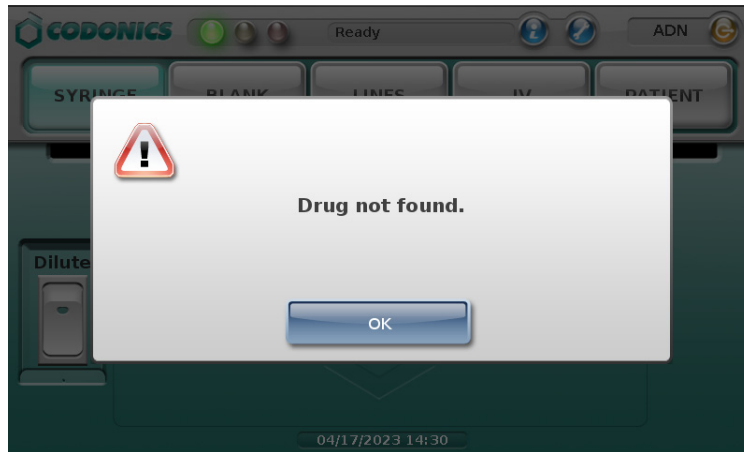

Press **OK** to dismiss the message.

Unknown Error Occurs

If an unknown error occurs during Administer Mode, an error message displays.

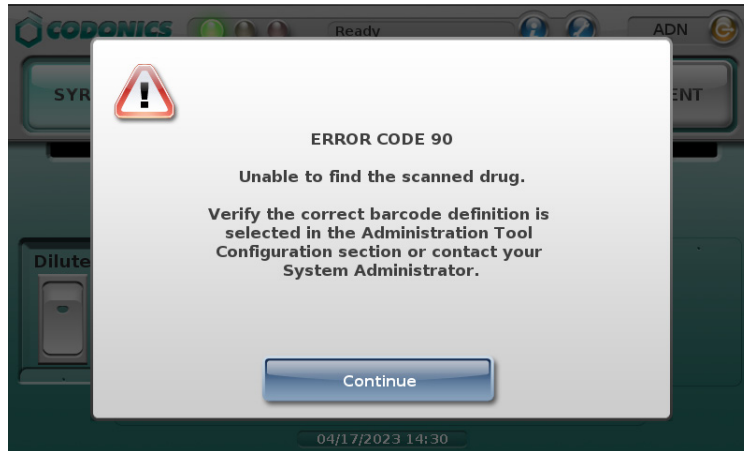

Press **Continue** to dismiss the message. Contact your SLS system administrator about the error.

7

Label Sizes and Template Packs

Label Sizes

The following label sizes are available:

Label Size	Size	Catalog Number	Supported Label Template Packs	Typical Usage
Small	48 x 17 mm	1SCB-SLX33-4	STD-S1, JP-S1, ME-S1, ZH-S1	5-ml syringes or smaller
Standard	60 x 22 mm	1SCA-SLX33-4	STD-1, STD-2, STD-3, JP-1, ME-1, ZH-1	5-ml syringes or larger

Label Template Packs

Several label template packs are available. The templates determine the content and layout of the printed labels. Each template pack is designed to support specific use cases.

The label template packs and their typical usage is described in the following topics. For detailed template pack information, refer to “Label Template Properties” on page 7-6.

Label template usage is configured in the SLS Administration Tool. For instructions, refer to the *SLS Administration Tool User Manual Addendum* (905-081-001).

STD-1

This pack includes traditional anesthesia templates for SLS standard-size labels. They provide all of the domestically-required labeling elements. The labels also comply with The Joint Commission NPSG.03.04.01 and meet the intent of ISO 26825, ASTM 4774 Standards, and ASA Guidelines.

Labels based on these templates can include a Dilution message when a drug is diluted or reconstituted. They can also be configured to print an Expiration Date or a Beyond Use Date (i.e., BUD).

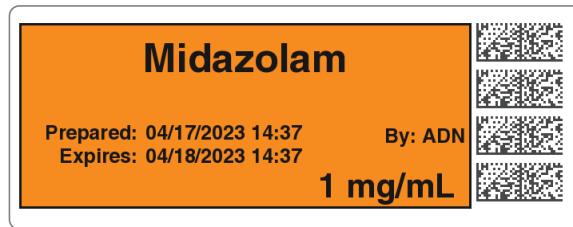

STD-1 Template 1



STD-1 Template 3

STD-2

This pack includes templates for SLS standard-size labels. In addition to the operating room, these templates can be used in other syringe preparation locations in the hospital. They provide all of the domestically-required labeling elements. The labels also comply with The Joint Commission NPSG.03.04.01 and meet the intent of ISO 26825, ASTM 4774 Standards, and ASA Guidelines.

Labels based on these templates include all of the TJC elements in the STD-1 templates. In addition, they can include dose and volume, an area for writing in the patient name or including a 1-D barcode that includes the NDC, or a write-in area for a second preparer's initials.



STD-2 Template 1

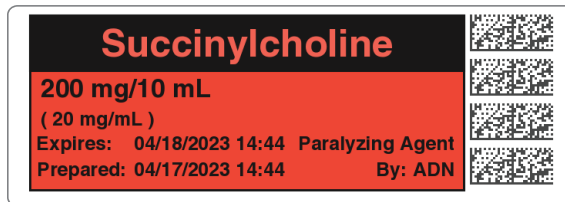

STD-2 Template 3

STD-3

This pack includes templates for SLS standard-size labels. In addition to the operating room, these templates can be used in other syringe preparation locations in the hospital. They provide all of the domestically required labeling elements. The labels also comply with The Joint Commission NPSG.03.04.01 and meet the intent of ISO 26825, ASTM 4774 Standards, and ASA Guidelines..

Labels based on these templates include all TJC elements in the STD-2 templates. In addition, they can include a free-form text field for information such as the facility name.



STD-3 Template 1

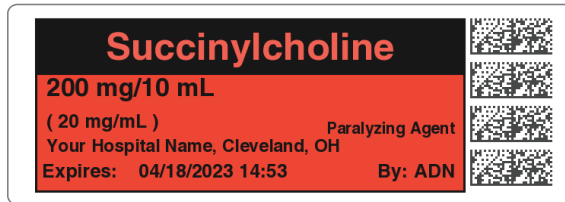

STD-3 Template 3

STD-3 labels can include Miscellaneous Field information. The information is entered in the formulary using the SLS Administration Tool and deployed to SLS PCS via a formulary package.

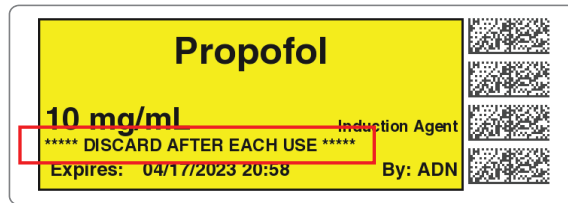

Label Template Properties

As identified in the following table, the templates have been designed for specific applications and uses. While they can be used for applications other than those for which they were designed, they might not be optimal for use in all applications. For example:

- Sites that want to include the total dose and total volume must use STD-2 or STD-3.
- Sites using Omnicell integration that require unique identification of the label preparer can use STD-1, STD-2, and EHR-1. Omnicell users who used label template ID-1 prior to version 2.4.0 can continue to use that template, as it will migrate and work with version 2.4.0.

Table 7-1. Label Template Properties

	STD-1	STD-2	STD-3
Target Applications			
Anesthesia	Yes	---	---
Anesthesia w/Omnicell AWS	---	---	---
Pharmacy	---	Yes	Yes
Nursing	---	Yes	Yes
BCMA (Bar Coded Medication Administration)	---	Yes	Yes
Label Info			
Size	Standard 60 x 22 mm	Standard 60 x 22 mm	Standard 60 x 22 mm
Labels/Roll	1,000	1,000	1,000
Included Fields			
Drug Name/Point Size	Yes/12 pt	Yes/12 pt	Yes/12 pt

Table 7-1. Label Template Properties (Continued)

	STD-1	STD-2	STD-3
Tallman Lettering/Point Size	Yes/12 pt	Yes/12 pt	Yes/12 pt
Concentration/Point Size	Yes/10 pt	Yes/10 pt	Yes/10 pt
Diluent	Yes	Yes	Yes
Total Dose/Total Volume	---	Yes	Yes
Message/Warning (e.g., Preservative Free)	Yes	Yes	Yes
Miscellaneous (free text; e.g., site name or instructions)	---	---	Yes
User Initials	Yes	Yes	Yes
User ID	---	---	---
Preparation Date and Time	Yes	Yes or 1D Barcode or Write-In box	Yes or 1D Barcode or Write-In box
Expiration Date and Time, or Beyond Use Date (BUD)	Yes	Yes	Yes
2D Barcode	Yes	Yes	Yes
Number of 2D Barcodes	4	4	4
1D Barcode	---	Yes or Prep. Date/Time or Write-In box	Yes or Prep. Date/Time or Write-In box
Dilution Message	Yes	---	---
Optional Feature Supported			
Batch/Copy Mode Printing	Yes	Yes	Yes
Administer Mode	Yes	Yes	Yes
Advanced Smart Scanning (SASS)	Yes	Yes	Yes

User Initials and User IDs in STD-1, STD-2, and EHR-1 Template Labels

By default, labels in the STD-1, STD-2, and EHR-1 template packs include user initials. However, these labels can be configured to include user IDs instead. Examples of these labels with user IDs are shown below.

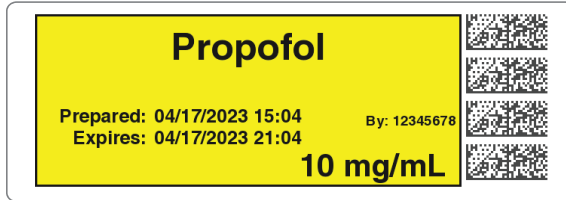

STD-1 label with user ID

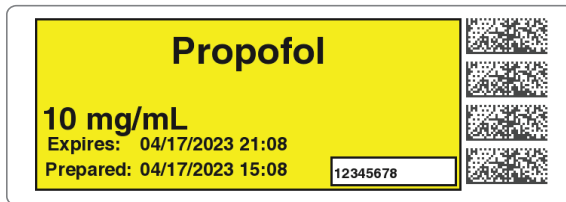

STD-2 label with user ID



EHR-1 label with user ID

Additional Label Template Packs

Label Templates That Support Over-Labeling (RBX-1)

These label templates allow over-labeling in specific applications [e.g., Intelligent Hospital System (IHS) RIVA robot, Baxter, Health Robotics]. The label is only supported in English.

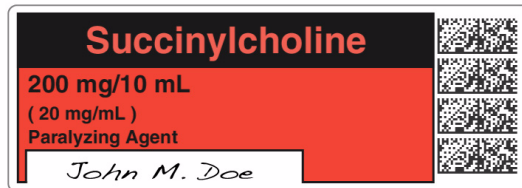

WARNING For RBX-1 labels, users should not rely on the expiration date embedded in SLS PCS label 2D barcode. The expiration date/time on the original label already affixed to the syringe should be used. This is because the time that the SLS label was prepared will be different than when the syringe was actually filled/prepared. Users should either leave the expiration time blank or the time should be set it to 0 for this label in the SLS Administration Tool.

Middle East and Australia Combination Drug Label Template Packs (ME-S1, ME-1)

These combination drug label template packs for the Middle East and Australia are based on the STD-2 template pack. They are available in small (ME-S1) and standard (ME-1) sizes. These templates also support a Local Anesthetic with Narcotic combination drug and a Relaxant Antagonist with Anticholinergic Agent combination drug.

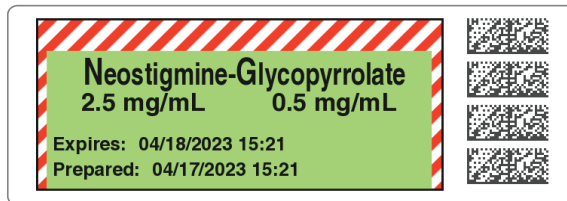
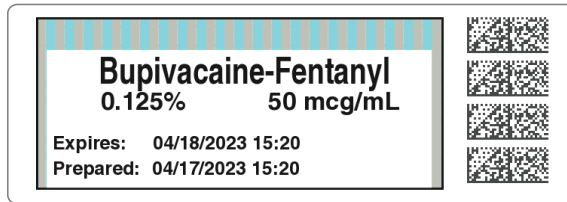

Middle East template examples

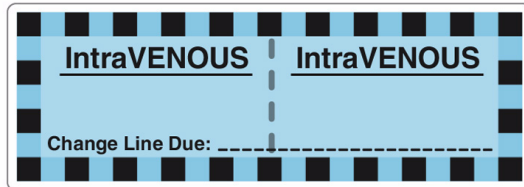
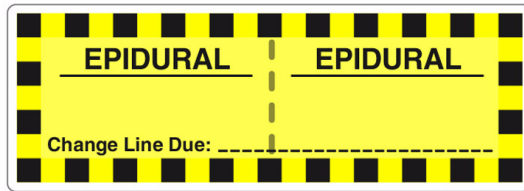

Australian Line Label template examples that are included in the ME-1 template pack

China Label Template Packs (ZH-S1, ZH-1)

These label template packs for China are available in small (ZH-S1) and standard (ZH-1) label sizes.



Japan Label Template Packs (JP-S1, JP-1)

These label template packs for Japan are available in small (JP-S1) and standard (JP-1) label sizes.

These templates can include a Use Date range, without the year (e.g., 4/17 16:45 ~ 4/18 16:45).

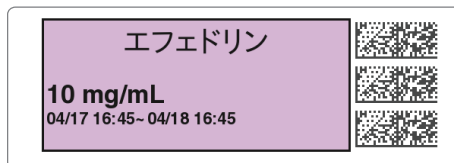

EHR Template Pack (EHR-1, EHR-2)

This label template pack is available for integration between SLS PCS-produced syringes and EHR systems. When scanned, the label's barcode provides the 10-digit NDC to an EHR system (e.g., Epic Anesthesia).



EBD Template Pack (EBD-3)

This label template pack is available for integration between SLS PCS-produced syringes and EHR systems and WasteLog Drug Diversion devices. When scanned, the label's barcode provides the 10-digit NDC to an EHR system (e.g., Epic Anesthesia) or a WasteLog Drug Diversion device.

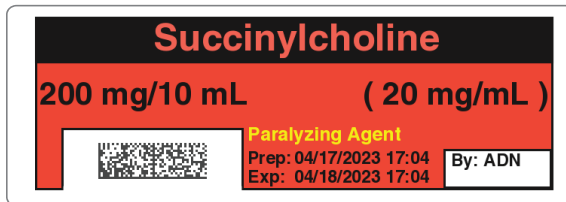

8

Third-Party Product Integration

This chapter describes features that support third-party production integration with SLS PCS.

SLS Wired Hand Scanner

SLS PCS supports using a Codonics-approved barcode scanner as a wired hand scanner for scanning labels on containers that are large or not easily scanned (for example, IV bags) by the built-in scanner.



NOTE: *Wired hand barcode scanner support requires a feature key on SLS PCS. Contact your Codonics Sales Representative to obtain the proper key.*

When using the wired hand scanner with SLS PCS, the scanner must be in SNAPI mode (SNAPI is the scanner's communication interface). By default, the scanner is shipped in SNAPI mode.

Note that following about the wired hand scanner:

- Support for the wired hand scanner on SLS PCS must be configured from the SLS Administration Tool.
- The use of the wired hand scanner requires a feature key on SLS PCS. Contact your Codonics Sales Representative to obtain the proper key.
- It is recommended that you purchase the DS4308-HC scanner from Codonics.

Connecting the Wired Hand Scanner to SLS PCS



WARNING The use of the wired hand scanner with SLS PCS can create a tipping hazard. Secure SLS PCS using the VESA mount points on the bottom of SLS PCS.

Included with the Codonics-approved barcode scanner is a wired hand scanner USB cable. This cable includes an RJ-45 connector that connects to the scanner and a standard USB connector that connects to a USB port at the rear panel.

To connect the wired hand scanner to SLS PCS:

1. Make sure that SLS PCS is powered off.
2. Clean and disinfect the wired hand scanner. Refer to “Cleaning and Disinfecting the Wired Hand Scanner” on page 8-4.
3. Push the RJ-45 connector of the wired hand scanner USB cable into the wired hand scanner RJ-45 port until you hear it click.
4. Gently pull the wired hand scanner USB cable to make sure that the RJ-45 connector is securely connected.

5. Insert the USB connector of the wired hand scanner USB cable into one of the USB ports at the rear panel, as shown in the following figure.

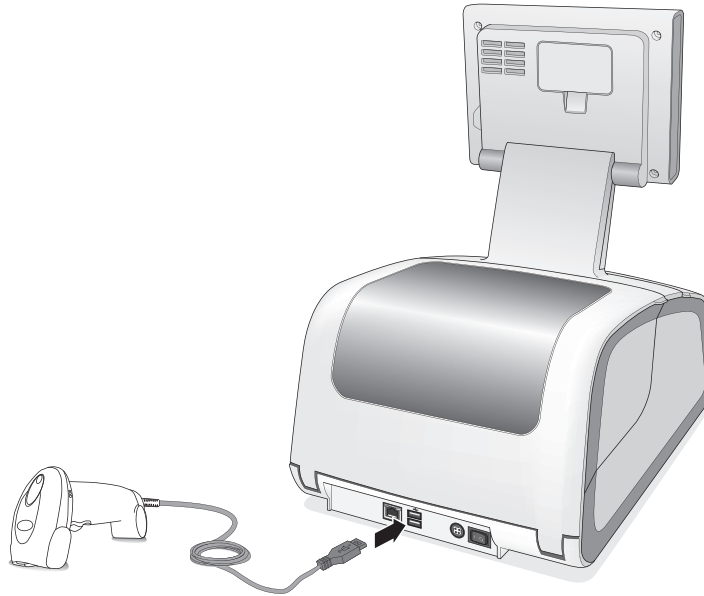

Testing the Wired Hand Scanner Communication with SLS PCS

After connecting the wired hand scanner and starting SLS PCS, the following prompt displays:

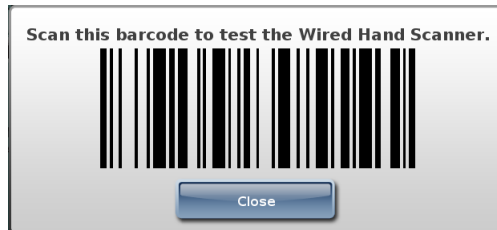

Scan the barcode displayed in the prompt.

This will confirm that the wired hand scanner is communicating with SLS PCS.

Configuring the Codonics-Approved Scanner for SLS PCS

By default, the Codonics-approved scanner is configured to work with SLS PCS. If you ever need to reconfigure the scanner to work with SLS PCS, please download the programming sheet from the Codonics web site and follow the instructions or contact Codonics Technical Support (+1 4440.243.1198 or support@codonics.com).

Cleaning and Disinfecting the Wired Hand Scanner

Following are the cleaning and disinfecting instructions for the wired hand scanner in environments that require daily or more frequent cleaning to prevent the spread of germs.

To avoid long-term damage to the wired hand scanner, it is recommended that you disinfect it only when necessary as determined by your hospital's policy.



WARNING Codonics makes no claims regarding the efficacy of the listed chemicals or methods as a means of controlling infection. Consult your hospital's infection control officer or epidemiologist.

Daily Cleaning and Disinfecting Instructions



WARNING Always disconnect the wired hand scanner or power off SLS PCS before cleaning it. An electrical shock could occur if SLS PCS is powered on and liquid is spilled into the wired hand scanner or SLS PCS.

1. Dampen a soft cloth with one of the approved cleaning or disinfecting agents or use pre-moistened wipes.
2. Gently wipe all surfaces, including the front, back, sides, top, and bottom of the wired hand scanner.



CAUTION Never apply liquid directly to the wired hand scanner. Be careful not to let liquid pool around the scanner window, trigger, cable connector, or any other area on the wired hand scanner.

3. Clean the trigger and in between the trigger and the housing. Use a cotton-tipped applicator to reach tight or inaccessible areas.
4. Immediately dry the scanner window after cleaning it with a soft non-abrasive cloth to prevent streaking.
5. Allow the wired hand scanner to air dry before using it.



NOTE: *If the temperature is low and the humidity is high, longer drying time is required. Warm temperatures and low humidity require less drying time.*

Monthly Deep Cleaning and Disinfecting Instructions

Maintain the wired hand scanner in good working order with a regular comprehensive cleaning routine to remove the natural build-up of dirt that occurs with everyday use on connectors, scanner window, and housing surfaces.

Housing surfaces: Follow the instructions in “Daily Cleaning and Disinfecting Instructions” in the previous page to perform a general cleaning of the housing surfaces.

Scanner window: Wipe the scanner window with a lens tissue or other material suitable for cleaning optical material such as eyeglasses.

RJ-45 port:

1. Dip the cotton portion of a cotton-tipped applicator in isopropyl alcohol.
2. Rub the cotton portion of the cotton-tipped applicator back-and-forth across the RJ-45 port. Do not leave any cotton residue on the port.
3. Repeat steps 1 and 2 at least three times.
4. Use the cotton-tipped applicator dipped in isopropyl alcohol to remove any grease and dirt near the connector area.
5. Use a dry cotton-tipped applicator (that is, with **no** isopropyl alcohol applied) to dry the RJ-45 port and the connector area.

Allow the wired hand scanner to air dry before using it.



NOTE: *If the temperature is low and the humidity is high, longer drying time is required. Warm temperatures and low humidity require less drying time.*

Common Login/Common Scan

SLS PCS supports Common Login/Common Scan so that it can be integrated with the following:

- BD Pyxis™ Anesthesia Station ES (PAS).
- Omnicell Anesthesia Workstation (AWS).
- Plexus TG Pharmacy Touch™ (Pharmacy management system and Capsa medication distribution cart application).

Common Login/Common Scan support provides the following features:

- Logging in or logging out of the BD Pyxis™ Anesthesia Station ES (PAS), Omnicell AWS, or Plexus TG Pharmacy Touch will automatically log in or log out the user from SLS PCS.
- Scanning the barcode of an item removed from the cart using the SLS PCS scanner will cause the information to be sent to the BD Pyxis™ Anesthesia Station ES (PAS), Omnicell, or Plexus TG system for inventory control and, at the same time, initiate printing of a syringe label on SLS PCS.



NOTE: Remote SLS PCS login names can be up to 255 characters.

SLS PCS can announce a voice alert when Remote Login/Logout fails. This feature can be configured using the Administration Tool (refer to Administration Tool Release Notes, part number 901-245-020).

Plexus TG Anesthesia Touch™

SLS PCS supports integration with Plexus TG Anesthesia Touch.

After a vial has been scanned at SLS PCS and a 2D barcode label generated, users have the following options to document administration in Anesthesia Touch.

- Manually administer the documentation in Anesthesia Touch using the iPad or Windows touchscreen.
- Scan the SLS PCS-generated barcode using the scanner at the Anesthesia Touch Windows station (typically close to the head of the patient, where the monitor is set up).
- Scan the SLS PCS generated barcode using the iPad's camera.
- Scan the initial SLS PCS-generated barcode again at SLS PCS, which triggers the administration pop-up box in Anesthesia Touch, as well as send concentration, drug class, auditory notifications, and so on.

Scanning the syringe label barcode on SLS PCS using Administer Mode will pass the syringe label information to the Plexus TG Anesthesia Touch.

B.Braun Space Pump

SLS PCS supports integration with the B.Braun Space Pump. B.Braun-compatible barcodes can be included on printed SLS syringe labels and then used to transfer data (i.e., drug name, concentration value, and concentration units) to a B.Braun Space Pump.



NOTE: *B.Braun Space Pump support requires a feature key on SLS PCS. Contact your Codonics Sales Representative to obtain the proper key.*



NOTE: *The Space Pump requires revision "J" or higher software in order to be compatible with SLS labels.*

Printing Patient Information on Labels

Using custom label templates, SLS PCS can receive patient information (e.g., Patient Name, Patient ID, Order ID, Patient Date of Birth, Patient Weight) from approved third-party equipment and print that information on labels.





WARNING To ensure that the correct drug is administered to the correct patient, the patient's wristband should be scanned. Do not scan the 1-D Patient ID barcode on the patient information syringe label when prompted to scan the actual patient wristband.



NOTE: Patient Information support requires a feature key. Contact your Codonics Sales Representative to obtain the proper key.

The Patient Information feature is configured in the SLS Administration Tool. For details on how to configure this feature, refer to SLS Administration Tool Technical Brief (901-245-015).

Starting a New Patient Case

When SLS PCS receives notification from third-party equipment that a patient case has been started, a message indicating that a new case has started is displayed.

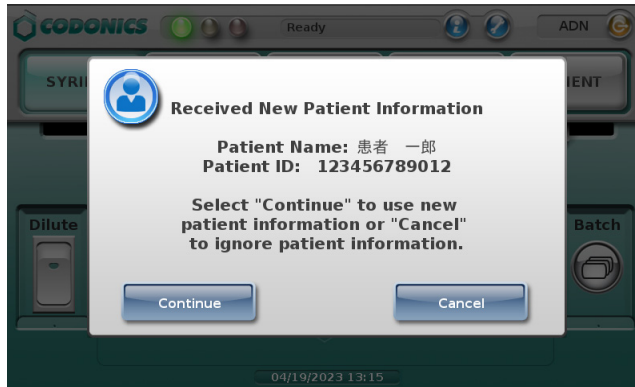

When starting a patient case while another case is already in progress, a warning message is displayed to indicate this.

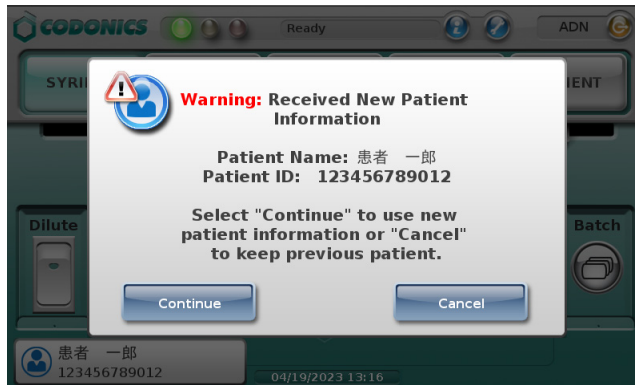

Labels That Support Patient Information

Labels using the Japan template pack JP-2 can include patient information. This standard label template conforms to the JSA standard and provides support for including patient information on them. Included on these labels is Patient Name, Patient ID, and a 1-D barcode that includes the Patient ID.



JP-2 syringe label example

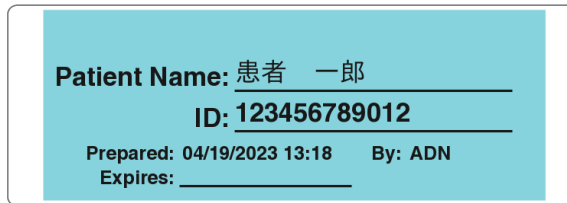

JP-2 Patient label example

Note the following about these labels:

- Patient Name can be up to 20 ASCII Characters (12 Kanji characters).
- Patient ID can be up to 12 numeric characters.

- Patient ID can be received as numeric and/or alpha characters. The set of numbers supported is 0-9 and the characters supported are dot (.), slash (/), colon (:), plus (+), and dash (-). For example, the Patient ID 00231-12345 will be displayed as well as encoded in the barcode. Optionally, the dash can be removed from the barcode. Contact Codonics for support removing the dash from the barcode.

How Invalid Patient Information Is Handled

If the patient information from a third-party system does not conform to the specifications (e.g., the Patient ID had more than 12 numeric characters), it will be replaced with an indication on the label that the data for that field is invalid. An example is shown below.

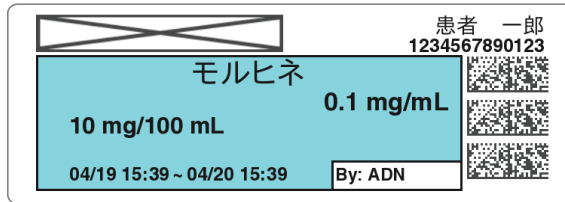

9

Maintenance

Ordering Supplies and Parts

The following table lists the label and print supplies that can be ordered from Codonics:

Supplies	Catalog Number
Type 2 ink cartridge	1SC2-LR233-4
Label media, small	1SCB-SLX33-4
Label media, standard	1SCA-SLX33-4
Wi-Fi adapter (optional)	SLS500-WIFI

The following table lists the replacement parts that can be ordered from Codonics:

Part	Catalog Number
Safe Label System external power supply	SLS-PS-3
Power cord, North America, Medical Grade	SP-00800
Power cord, Europe, Medical Grade	SP-00418
Media Hubs	SP-00560
Receive Tray	SP-00580

To order parts in the USA, contact Codonics Customer Service at:

Phone: +1 440.243.1198
Fax: +1 440.243.1334
Toll Free: 800.444.1198 (USA only)
Web: www.codonics.com

To order parts outside of the USA, contact your Codonics Customer Support Representative.

Cleaning the Enclosure



WARNING Always power off the system before cleaning. An electrical shock could occur if the system is powered on and liquid is spilled into it. Refer to “Powering Off the System” on page 3-45.

- To clean the system’s enclosure, use a clean, lint-free cloth moistened with either warm water and mild soap, a diluted non-caustic detergent, or one of the following approved cleaning agents:
 - Ammonia: Dilution of Ammonia <3%
 - Alcohol: Ethanol 70%, Isopropanol 70%.
- Over time, ink overspray might gather at the base of the device. The device uses a vacuum system to gather most of this ink on a series of saturation pads. Eventually, these pads might need to be replaced. Contact Codonics Technical Support to determine if pad replacement is necessary.
- If ink has gotten onto the system’s enclosure, it can be cleaned with an ammonia-based window cleaner and a lint-free cloth.

- If scanning barcodes is inconsistent or the device is having difficulty scanning, clean the scanner's glass window.

Cleaning Precautions

To avoid damage to the device, observe the following general precautions for cleaning the device:

- Apply the cleaner to a clean, lint-free cloth first and then clean the device. Liquid applied directly to the device could possibly leak inside the device and cause damage. Use extra caution when cleaning around the vents on the back of the touch screen and rear panel.
- Allow the device to completely dry before operating it again.
- Many plastic components are used in SLS PCS construction. Coat flecking and deformation is likely to occur if the device is wiped with chemical dusters, benzene, thinners, insecticides, or other solvents. Rubber and PVC materials left in contact with SLS PCS for extended periods of time will cause damage. Never use petroleum-based solutions or abrasive cleansers.
- Never use abrasive material.
- Always dilute cleaning agents according to the manufacturer's instructions, or use the lowest possible concentration.
- Do not allow the cleaning agent to remain on the device surfaces. Wipe it off immediately with a lint-free cloth moistened with water.

Disinfecting the Enclosure

It is recommended that you disinfect the product only when necessary as determined by your hospital's policy, to avoid long-term damage to the product.

The device must be cleaned first, as described in "Cleaning the Enclosure" on page 9-2, before using a general disinfecting agent.

Recommended disinfecting agents include:

- 1 part household bleach and 5 parts water solution
- A-456-N
- Virex II 256
- PDI Super Sani-Cloth[®]



WARNING Codonics makes no claims regarding the efficacy of the listed chemicals or methods as a means of controlling infection. Consult your hospital's infection control officer or epidemiologist.

Disinfecting Precautions

To avoid damage to the device, observe the following general precautions for disinfecting the device:

- Do not use Povodine, Sagrotan, or Mucoxit disinfecting agents or strong solvents (for example, acetone).
- Do not use any disinfecting agents that corrode or damage polycarbonate.

Installing Update Packages

SLS formulary and configuration packages, SLS system software, and user packages can be installed remotely from the SLS Administration Tool, if the PC on which the SLS Administration Tool is running and SLS PCS are connected to the same network. They can also be installed manually at SLS PCS.

A formulary update package includes the formulary database, which contains drug records and associated content such as drug-specific label templates, sound files, watermark images, and localization files. A configuration package includes the configuration settings for SLS PCS.

Formulary, configuration, user, and system software updates can also be configured into one multiple update package.



CAUTION Installing system software should only be performed as directed by Codonics Technical Support. Do not attempt to install system software without the assistance of Codonics Technical Support.

For a multiple update package, all update packages have to be at the same major SLS software version. For example:

- When upgrading from major version 2.6.0 to 3.0.0, create a combined package of 3.0.0 software, formulary and configuration packages.

- Minor version updates (for example, from version 2.6.0 to 2.6.1) affect only the SLS software and not the formulary or configuration. However, software updates do remove the formulary. So you first have to install the 2.6.1 software update package, then install a 2.6.0 formulary package. Because configuration is not removed during the 2.6.1 software upgrade, a 2.6.0 configuration package does not have to be installed again.

Manually Installing an Update Package



WARNING The formulary or configuration should be updated only when SLS PCS is not in use.

An administrator uses the SLS Administration Tool to create these update packages and store them on a USB flash drive for manual installation in an SLS PCS. For more information about creating update packages, refer to the *SLS Administration Tool User's Manual*.



NOTE: If the formulary update package contains a formulary in Test/Review mode, the yellow LED on the Dashboard will be on and a system message will indicate that the system is in Test/Review mode. Any syringe label that is printed while in this mode will have a watermark indicating that it is a test label and for demo use only.



NOTE: It is strongly recommended that each SLS PCS customer create and set up a process and audit plan to check that the latest, approved versions of the formulary and configuration are correctly deployed on each SLS PCS.



To manually
install an update
package

1. Log in to SLS PCS, as described in “Logging In” on page 3-3.
2. Insert the USB flash drive into the USB port on the left side of the touch screen.



Inserting the USB flash drive into the touch screen USB port

You are prompted to confirm installation of the packages or software on the USB flash drive.

3. Press the **Yes** button to continue with the installation.

After copying the installation files to internal memory, the system displays a message indicating that the installation process is beginning and that the USB flash drive can be removed.

4. Remove the USB flash drive.

The system displays status of the installation process. During installation, the system is not usable and cannot be interrupted.

When installation is complete, the system restarts automatically.



CAUTION The SLS PCS customer is responsible for ensuring that the correct formulary is being installed in SLS PCS.



CAUTION Practice standard information technology (IT) precautions to protect data associated with the formulary (for example, securing the content of the USB flash drive on which the formulary update package is stored).



CAUTION The SLS PCS customer is responsible for the accuracy of the data in the formulary, including drug data that has been copied from third-party drug databases.

Remotely Installing Update Packages

A user who has Read-Write privileges for the SLS Administration Tool Device Manager can remotely initiate the installation of an update package from the SLS Administration Tool at any time. However, the installation will begin only when there is no user logged into SLS PCS.

When an update package has been downloaded to SLS PCS and is ready to be installed, the status message “Update Pending” is displayed in the Dashboard.

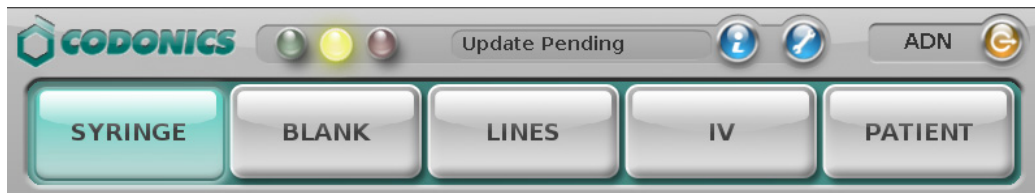

“Update Pending” message in Dashboard

When the user logs out, the following prompt is displayed. The user has the option of postponing the installation or beginning it immediately.

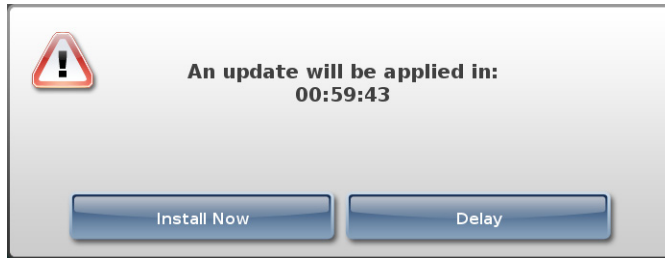

Update package prompt



NOTE: If the user postpones the package installation by pressing the **Delay** button in the package Update prompt, either a user must log in to and then out of SLS PCS or it must be restarted for the Update prompt to be displayed again. Otherwise, the package installation will not occur.

When an update package is being installed, a message indicating that the installation is occurring is displayed.

Manually Installing SLS System Software



To manually
install system
software

1. Shut down and power off SLS PCS.
2. Remove the USB SmartDrive from the USB port inside the touch screen rear panel door.

3. Insert the software installation USB flash drive into the USB port at the left side of the touch screen.

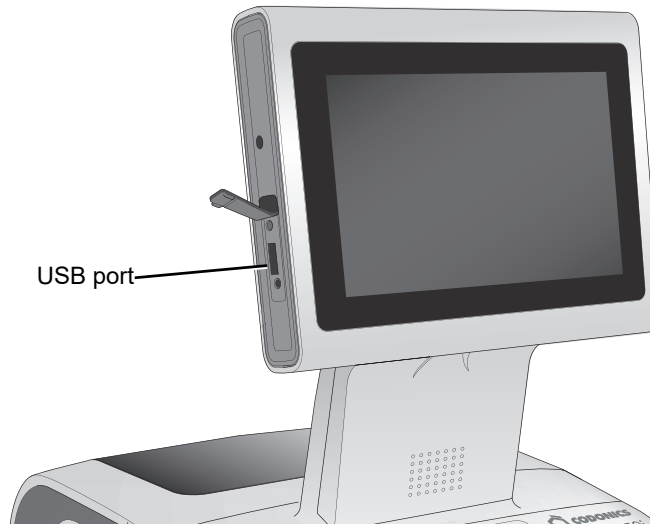

USB port at left side of touch screen

4. Power on SLS PCS.
5. Wait several minutes for the progress bar to complete and the message to remove the software installation USB drive to display.
6. Leave SLS PCS powered on.
7. Remove the software installation USB flash drive.

8. Re-insert the USB SmartDrive in the back access panel.

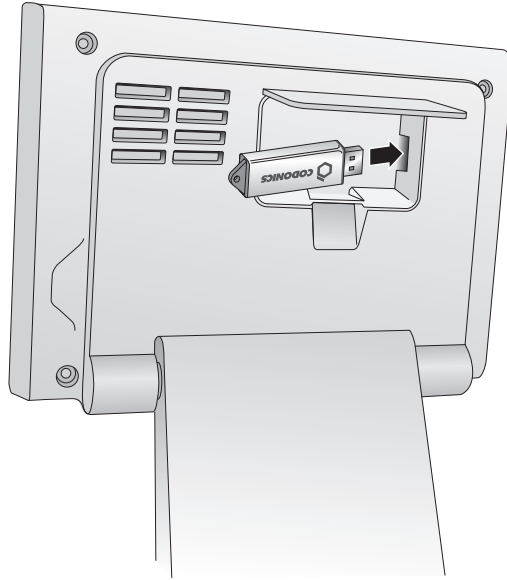

Inserting the SmartDrive into the USB port inside the touch screen rear panel door

SLS PCS automatically restarts.

9. Wait for SLS PCS to finish installing the software and display the Login screen.

Removing the Rear Cover

You might need to remove the rear cover for cleaning purposes, to clear a label jam, or to load labels in a restricted space.



To remove the rear cover

1. Partially open the rear cover (do not fully open the cover).
2. Hold the cover on both sides and gently lift it up until the hinges separate.
3. Carefully pull the cover away from SLS PCS.

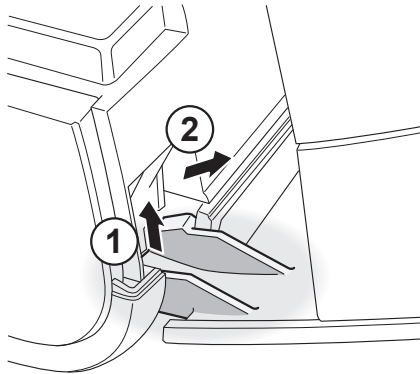

Removing the rear cover



WARNING Re-glove in the event of a cut or pinch to prevent using a possible torn glove.

Swapping Systems

You can move the SmartDrive from one SLS PCS to another to move the system's configuration and formulary database, thus allowing the second SLS PCS to operate exactly like the first. This feature is helpful when swapping SLS PCS for service purposes.

To swap systems, contact Codonics Technical Support so that they can direct you through the required steps.



NOTE: When swapping systems, if SLS PCS has a Codonics Wi-Fi adapter, remember to also move the adapter to the new SLS PCS.

Preparing the System for Shipping

If you have to ship SLS PCS for any reason (for example, to return it to Codonics for service), you must use the original boxes and packing materials. If you do not have the original box and packing materials, contact your Codonics representative for instructions on how to return SLS PCS.



To prepare
SLS PCS for
shipping

1. With SLS PCS powered on, open the front cover and press the Unload button to back out the label media so that it can be removed.

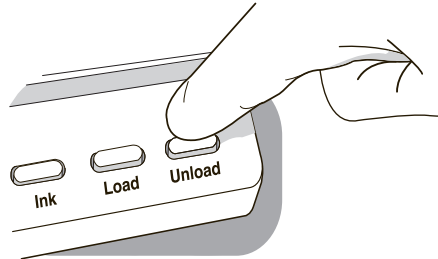

Unload button

2. Open the rear cover, remove the label media, and close the rear cover.
3. Shut down SLS PCS. Refer to “Shutting Down or Restarting the System” on page 3-43.
4. Press the Ink button.

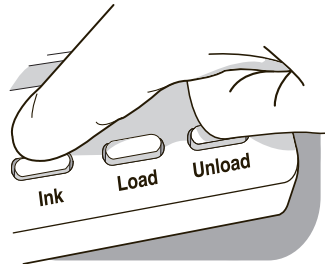

Ink button

The ink cartridge carriage moves to a position that allows you access to the ink cartridge.

5. Remove the ink cartridge and close the front cover. For information about how to remove the ink cartridge, refer to “Installing the Ink Cartridge” on page 2-21.
6. Set the Power switch on the rear panel to Off.

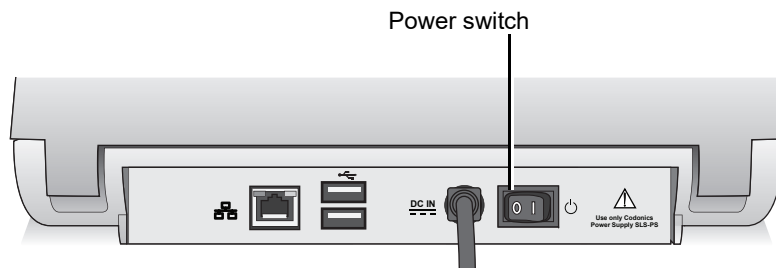

Power switch on the rear panel

10

Troubleshooting

Status Indicators

The Dashboard includes three LED-style lights that indicate the overall status of SLS PCS, a Muted icon if the volume has been turned off, and a status message area.

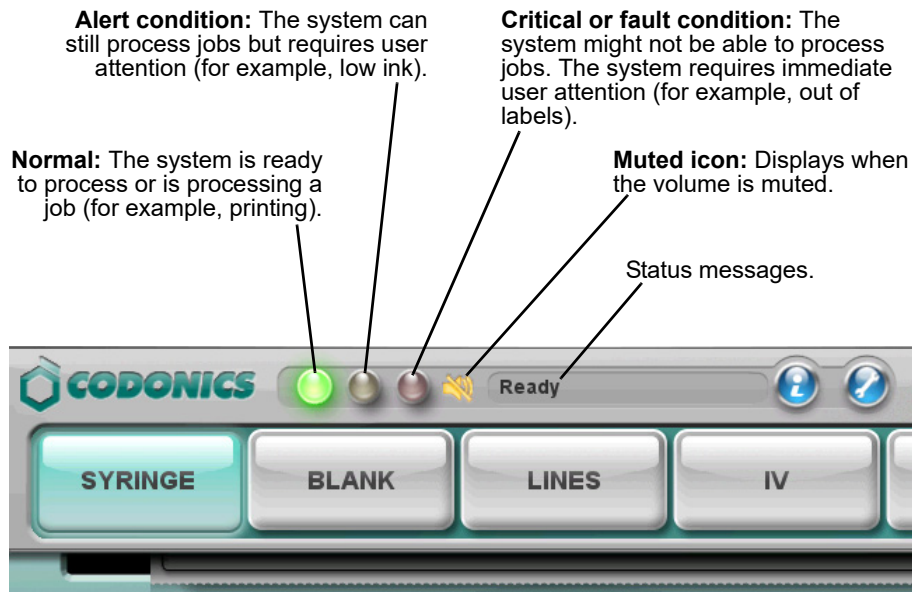

Displaying System Information

You can display information about SLS PCS configuration and its current status.

Press the System Information button.



To display
system
information

System Information button



The **System Information** window displays.

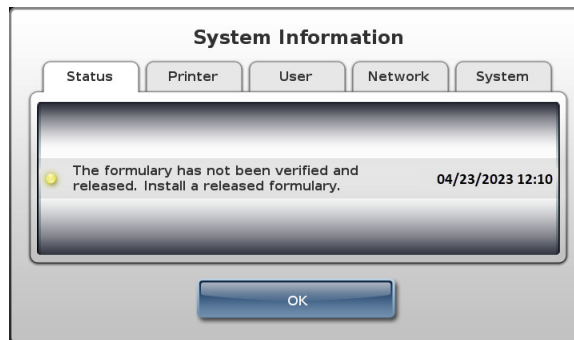

Press the **OK** button to dismiss the **System Information** window.

The tabs in the **System Information** window include the information described in the following topics.

Status Tab



- A list of active system status messages:
 - Each line of the list has a descriptive message about the status
 - To the left of each message, there is an LED status indicator that displays the color-coded severity of the system state
 - To the right of each message, the time this status message first appeared is indicated

The LED status indicator severity states are:

- **Green:** Normal operation. No issues.
- **Yellow:** Alert condition. The system can still process jobs but requires user attention (for example, low ink).

- **Red:** Critical or fault condition. The system might not be able to process jobs. The system requires immediate user attention (for example, out of labels).

Printer Tab

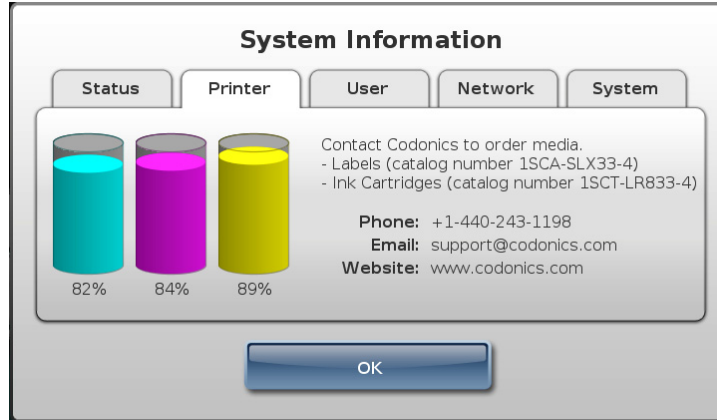

- Percent of ink remaining in the ink cartridge for all three colors
- Codonics part numbers for ordering ink cartridges and label media
- Codonics contact information for ordering ink cartridges and label media

User Tab

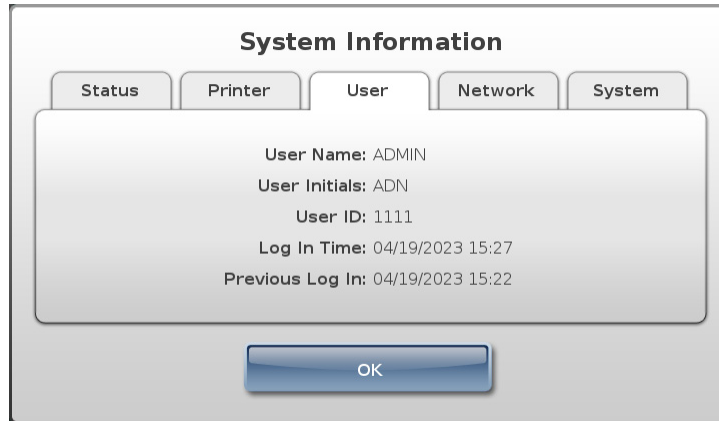

- Name of the currently logged-in user, along with their initials, ID, current login time, and previous login time

Network Tab

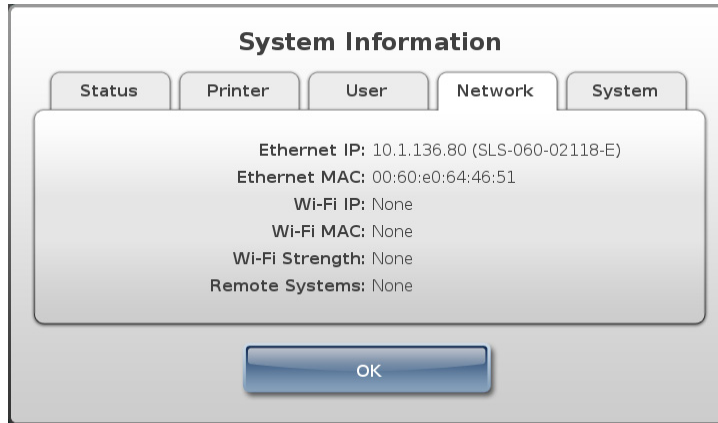

- Ethernet IP address (SLS device name)
- Ethernet MAC address
- Wi-Fi IP address
- Wi-Fi MAC address
- Wi-Fi signal strength
- Remote systems

System Tab



- Serial number of the system
- Current software version
- Current printer firmware version
- Current scanner firmware version
- Current formulary version
- Current users version
- Current configuration version
- License code

System Status Messages

The following table lists the system messages that can be displayed on the Dashboard and the corresponding longer version of the message that is displayed on the **Status** tab of the **System Information** window.

Table 10-1. System Status Messages

Messages Displayed on Dashboard	Messages Displayed on Status Tab of System Information Window
Ready	Ready.
Printing	Printing label.
Ink Low	Ink low. Replace ink cartridge soon.
Labels Low	Labels low. Replace labels soon.
Printer Error	Printer error.
Printer Cover Open	Printer Cover is open.
No Labels	Labels out. Load a roll of labels.
No Ink	Ink out. Load new ink cartridge.
No Ink Cartridge	Ink cartridge missing. Insert ink cartridge.
No Printer	Printer error. Cycle power or contact Codonics.
No Scanner	Barcode Scanner error. Cycle power or contact Codonics.
Auto-logout Imminent	Auto-logout in # seconds. Touch screen.
Update Found	Update found. Analyzing...
Update Invalid	Update invalid. Please remove the USB drive.

Table 10-1. System Status Messages (Continued)

Messages Displayed on Dashboard	Messages Displayed on Status Tab of System Information Window
Update Failed	Update failed to install. Try again or contact Codonics.
Update Required	Applying updates... Do NOT power off.
Out of Service	System out of service. Refer to the message on the Status tab of the System Information window. The message includes a description of the problem and suggested corrective actions.
SmartDrive Removed	SmartDrive missing.
SmartDrive Not Found	SmartDrive missing.
SmartDrive Data Damaged	SmartDrive data damaged.
SmartDrive Invalid	Cannot verify authenticity of the SmartDrive.
No Key Found	No key found. Not for clinical use.
Demo Mode	Install the Clinical Feature Key in order to use the device without limitations.
Test Formulary	The formulary has not been verified and released. Install a released formulary.
No Formulary	No formulary is installed. Install a formulary to scan drug containers.
Disk Space Low	Running low on internal disk space. Contact Codonics.
Expiring Feature	One or more Feature Keys are approaching the expiration date.
Drug Failed Verification	Drug failed verification. Install an updated formulary.
Label Failed Confirmation	Scan of barcode on printed label does not match what was printed on syringe label.

Table 10-1. System Status Messages (Continued)

Messages Displayed on Dashboard	Messages Displayed on Status Tab of System Information Window
Label Failed Confirmation	Failed to confirm a printed syringe label because user indicated unable to scan.
Label Failed Confirmation	Failed post print confirmation of syringe label because inactivity time-out occurred.
Label Failed Confirmation	User selected option to fail the visual inspection of the contents of the syringe label.
Update Transferring	An update is currently being transferred.
Update Pending	A network update will be installed upon logout.

Troubleshooting Common Problems

The following table lists common problems, their possible causes, and how to solve them.

Table 10-2. Troubleshooting

Problem	Possible Causes	Solutions
System Problems:		
The system fails to power on.	The system does not have power connected.	Check the power cables. Check the power supply switch on the rear panel.
	The external power supply has failed.	Replace the external power supply.

Table 10-2. Troubleshooting (Continued)

Problem	Possible Causes	Solutions
The system has lost power.	The system does not have power connected.	Check the power cables. Check the power switch on the rear panel. Cycle power to the system.
	There is an internal power problem.	Contact Codonics Technical Support (+1 440.243.1198).
During startup, the system indicates that the SmartDrive is missing (error codes 70, 71).	The SmartDrive is not inserted in the USB port inside the touch screen rear panel door.	Insert the SmartDrive. Refer to "Inserting the SmartDrive" on page 2-18.
During startup, the system indicates that the SmartDrive is not compatible with the SLS application (error code 73).	The version number on the SmartDrive does not match the version number of the SLS application.	Contact Codonics Technical Support (+1 440.243.1198).
The system is not responding.	A variety of conditions.	Cycle power to the system.
The system starts in an error state.	A variety of software and/or hardware conditions.	Follow on-screen resolution prompts to correct issues.
		Refer to the on-screen information section about error codes.
		Contact Codonics Technical Support (+1 440.243.1198).
The user cannot log in.	The PIN has been forgotten or misplaced.	Create a new badge for the user with a new user ID.

Table 10-2. Troubleshooting (Continued)

Problem	Possible Causes	Solutions
The system indicates that it is in Test/Review mode.	<p>The most recent formulary update package that was installed contains a formulary in Test/Review mode. This mode is used to test formularies before they are actually deployed on SLS PCSs.</p> <p>The installed localization pack is in Test/Review mode and has not been validated yet by Codonics.</p>	<p>To return SLS PCS to the normal mode, a formulary update package at the Approved level must be installed. For more information about formulary levels, refer to the <i>SLS Administration Tool User's Manual</i>.</p> <p>Install a localization pack that has been validated by Codonics. For more information, refer to the <i>SLS Localization Reference Guide</i> and the <i>SLS Administration Tool User's Manual</i>.</p>
The system indicates that a cover is open (error code 7).	The front or rear cover is open. While it is open, the printer cannot print labels.	Close the front or rear cover.
The system indicates that the printer is not responding (error code 8) or has an error (error codes 9, 12).	There is a problem with the label printer.	<p>Cycle power to the system.</p> <p>If the problem persists, contact Codonics Technical Support (+1 440.243.1198).</p>
The system indicates that disk space is low (error code 61).	Storage capacity is at or below 10%.	Contact Codonics Technical Support (+1 440.243.1198).
The system indicates that disk space is full (error code 62).	Storage capacity is below 1%.	Contact Codonics Technical Support (+1 440.243.1198).
The system indicates that the data on the SmartDrive is damaged (error code 72).	The SmartDrive is corrupted.	Contact Codonics Technical Support (+1 440.243.1198).

Table 10-2. Troubleshooting (Continued)

Problem	Possible Causes	Solutions
The system indicates that the SmartDrive is not valid (error code 74).	The SmartDrive does not have the necessary files.	Insert a valid SmartDrive and restart the system. If the problem persists with a SmartDrive that you believe to be valid, contact Codonics Technical Support (+1 440.243.1198).
Copying log files failed (error code 84).	The USB flash drive is full.	Delete files on the flash drive to provide enough storage space for the log files.
	The USB flash drive is damaged.	Try using another flash drive.
	The USB flash drive was removed while the copy operation was still being performed.	Insert the SmartDrive in the USB port inside the touch screen rear panel door and copy the log files again.
The system indicates that a system setting was not found (error code 85).	The installed version of the configuration is not compatible with the installed version of the SLS application.	Update the SLS application software or create a compatible version of the configuration update package and install that package. For more information, refer to the <i>SLS Administration Tool User's Manual</i> .
<i>Touch Screen Problems:</i>		
The touch screen does not respond properly when touched.	Potential hardware problem.	Contact Codonics Technical Support (+1 440.243.1198).
<i>Formulary Problems:</i>		
The formulary fails to load (error code 60).	The formulary database is corrupt.	Clear the error; refer to "Clearing Errors" on page 3-30. Create and load a new formulary update package. For information about how to create a formulary update package, refer to the <i>SLS Administration Tool User's Manual</i> .

Table 10-2. Troubleshooting (Continued)

Problem	Possible Causes	Solutions
The system indicates that the updated formulary is invalid (error code 81).	The formulary update package that was installed is damaged or the version of the formulary update package is not compatible with the current SLS software.	Create and load a new formulary update package. For information about how to create a formulary update package, refer to the <i>SLS Administration Tool User's Manual</i> . If the problem persists with a new formulary update package, contact Codonics Technical Support (+1 440.243.1198).
The system indicates that the formulary update is incomplete (error code 82).	The formulary update package did not install correctly.	Reinstall the formulary update package. If the problem occurs again, create and load a new formulary update package. For information about how to create a formulary update package, refer to the <i>SLS Administration Tool User's Manual</i> . If the problem persists when installing the new formulary update package, contact Codonics Technical Support (+1 440.243.1198).

Table 10-2. Troubleshooting (Continued)

Problem	Possible Causes	Solutions
<i>Drug Container Barcode Verification Problems:</i>		
A drug container failed verification when the barcode was scanned to print a syringe label (error code 20).	The user indicated that the drug in the formulary that matched the Container ID in the scanned drug container barcode is not the same drug as that in the drug container. To prevent a syringe being improperly labeled, that drug record is assigned a verification status of Failed and a label will not be printed anytime this drug container's barcode is scanned.	Make sure the barcode on the drug container is of good quality. Use the SLS Administration Tool to correct the drug information in the Master Drug Database (MDD), create a new version of the formulary update package, and load the new version into SLS PCS. For more information, refer to the <i>SLS Administration Tool User's Manual</i> .
When a drug container's barcode is scanned to print a syringe label, the system indicates that the barcode previously failed drug verification (error code 21).	The first time this drug container barcode was scanned, the user indicated that the drug in the drug container did not match the drug found in the formulary with the same Container ID. To prevent a syringe being improperly labeled, the drug record's verification status was set to Failed and a label will not be printed anytime this drug container's barcode is scanned.	Make sure the barcode on the drug container is of good quality. Use the SLS Administration Tool to correct the drug information in the MDD, create a new version of the formulary update package, and load the new version into SLS PCS. For more information, refer to the <i>SLS Administration Tool User's Manual</i> .
<i>Printed Syringe Label Confirmation Problems:</i>		
The displayed label in the pre-print confirmation screen was incorrect so the user pressed the Cancel button (error code 25).	There is an error in the formulary (unless the user just decided that they did not want to print the label).	If the label content or label color are incorrect, discard the label or the syringe (if the label is affixed to it), and contact your SLS system administrator.

Table 10-2. Troubleshooting (Continued)

Problem	Possible Causes	Solutions
The confirmation scan of a printed syringe label's barcode failed (error codes 30, 31, 32).	The barcode that was scanned was not a syringe barcode (error code 30).	Scan the barcode on the syringe label that was just printed.
	The barcode that was scanned was not the syringe barcode of the label that was just printed (error codes 31, 32).	Make sure that the label whose barcode you are scanning is the label that was just printed. <ul style="list-style-type: none">• If it is not, then scan the correct label.• If it is, then the label did not print correctly. Do not use the label or the syringe (if the label is affixed to it). Contact your SLS system administrator and Codonics Technical Support (+1 440.243.1198) to notify them of the problem.

Table 10-2. Troubleshooting (Continued)

Problem	Possible Causes	Solutions
The visual confirmation of a printed syringe label failed [that is, on the post-printing confirmation dialog box, the user has pressed the No button (error code 37), and then pressed the Content Error (error code 35) or the Printing Error (error code 36) button].	The wrong drug information was printed on the syringe label (error code 35).	Discard the label or the syringe (if the label is affixed to it), try printing the syringe label again, and contact your SLS system administrator to notify them of the problem. If the wrong drug information is printed again, then the match between the Container ID in the scanned barcode and the Container ID in the drug record in the formulary is incorrect. The drug record in the formulary needs to be corrected. For more information, refer to the <i>SLS Administration Tool User's Manual</i> .
	The label print quality is not satisfactory (error code 36).	Discard the label or the syringe (if the label is affixed to it), try printing another one, and contact your SLS system administrator to notify them of the problem. If the problem continues, refer to the label problems and solutions described below in this table.
The confirmation of a printed syringe label is not able to be performed (error code 33).	The user pressed the Unable to Scan button.	Discard the label or the syringe (if the label is affixed to it). Print another label or a blank label. If the problem persists, contact your SLS system administrator.

Table 10-2. Troubleshooting (Continued)

Problem	Possible Causes	Solutions
Label Printing Problems:		
The test label fails to print (error code 1).	A variety of printer conditions.	Print the label again. Check to make sure that there are labels on the label media and that the label media is properly loaded. Check the ink cartridge. Cycle power to the system.
The test label did not print correctly (error code 2).	A variety of printer conditions.	Refer to the appropriate problem in this table for a solution.
The system indicates that the printing of a syringe label was canceled.	The user canceled the print operation at the pre-print confirmation.	If the content of the preview syringe label did not match the drug container whose barcode was scanned, contact your SLS system administrator to correct the drug record problem in the formulary.
The system indicates that it is out of label media (error code 6).	The label media is empty.	Install label media. Refer to "Loading or Replacing the Label Media" on page 2-26.

Table 10-2. Troubleshooting (Continued)

Problem	Possible Causes	Solutions
Print is light, there is banding or gaps, or there is no printed image.	The ink cartridge is low or out of ink.	Replace the ink cartridge. Refer to “Installing the Ink Cartridge” on page 2-21.
	The ink cartridge is clogged.	Purge the ink cartridge (refer to “Cleaning the Ink Cartridge Nozzles” on page 3-15). Remove the ink cartridge and wipe the copper contacts with an alcohol-based wipe.
	The ink cartridge still has the protective seal on it.	Remove the ink cartridge and peel the protective seal from the cartridge.
	Low-quality labels are being used.	Use only Codonics labels. For ordering information, refer to “Ordering Supplies and Parts” on page 9-1.
	The ink cartridge has been refilled.	Use only new ink cartridges from Codonics.
Printed content is not properly centered on the label.	The media path is out of alignment.	Adjust the media path. Refer to “Adjusting the Media Path” on page 3-18.
Labels are incorrectly cut.	The cutter is out of adjustment.	Contact Codonics Technical Support (+1 440.243.1198).
	Labels are not being advanced correctly.	Reload the labels.
	The label offset is not set correctly.	Adjust the media path. Refer to “Adjusting the Media Path” on page 3-18.
Printed labels are not being cut.	The cutter is not properly positioned.	Contact Codonics Technical Support (+1 440.243.1198).

Table 10-2. Troubleshooting (Continued)

Problem	Possible Causes	Solutions
Labels are being printed but are not being dropped into the output bin.	Labels are jammed in the media path.	Clear the label jam. Refer to “Clearing a Label Media Jam” on page 10-22.
	A label is jammed in the discharge slot above the output bin.	Place your finger on the leading edge of the label and pull it forward to pull the label from the discharge slot.
Labels are not being printed correctly. For example, after scanning a barcode to confirm a printed label, the system displays an error message indicating that the scanned barcode is not correct.	The software, scanner, or printer is not operating properly.	Follow on-screen resolution prompts to correct issues.
Poor print quality.	Saturation.	Adjust the label black levels. Refer to “Adjusting the Label Black Levels” on page 3-20
	The wrong labels are loaded.	Load the correct labels for SLS PCS.
	The ink cartridge is not functioning properly.	Replace the ink cartridge with a proper SLS ink cartridge from Codonics. Refer to “Installing the Ink Cartridge” on page 2-21.
	The ink cartridge has been refilled.	Use only new ink cartridges from Codonics.

Table 10-2. Troubleshooting (Continued)

Problem	Possible Causes	Solutions
<i>Ink Cartridge Problems:</i>		
The system indicates that the ink cartridge is low (error code 5) on ink or out of ink (error code 4).	The ink cartridge is about to become empty or is empty.	Install a new ink cartridge. Refer to “Installing the Ink Cartridge” on page 2-21.
The system indicates that the ink cartridge is not installed (error code 3).	There is no ink cartridge in the carriage.	Install an ink cartridge. Refer to “Installing the Ink Cartridge” on page 2-21.
The ink cartridge carriage is not moving (error code 9).	An obstruction is preventing the ink cartridge carriage from moving.	Open the front cover and remove the obstruction. Press the Ink button to reset the position of the ink cartridge carriage.

Table 10-2. Troubleshooting (Continued)

Problem	Possible Causes	Solutions
Barcode Scanner Problems:		
The barcode scanner is not scanning.	The scanner's glass window is dirty.	Clean the scanner's glass window. Refer to "Cleaning the Enclosure" on page 9-2.
	The low-light red light is on, but the scanner laser cross-hairs are not on.	Shutdown the system from the touch screen and then cycle power to the system.
	The barcode symbology is not supported.	Contact Codonics Technical Support (+1 440.243.1198).
	The barcode on the printed syringe label has poor quality.	Follow the on-screen resolution prompt to fail the post-confirmation and try printing the label again. If the barcode quality is still poor, contact Codonics Technical Support (+1 440.243.1198).
	The barcode is incorrectly positioned.	Place the container or syringe below the scanner so that the red cross-hair lines up on the barcode. Placing the container or syringe closer to the cover, almost resting it on the cover, instead of placing it closer to the scanner, will also provide better results.
The system indicates that the scanner is not responding (error code 18).	There is a problem with the barcode scanner.	Cycle power to the system. If the problem persists, contact Codonics Technical Support (+1 440.243.1198).

Table 10-2. Troubleshooting (Continued)

Problem	Possible Causes	Solutions
Network Problems:		
SLS PCS will not connect to the network.	There are general network connectivity issues at the access point or SLS PCS.	Verify that other devices connected to the network via the same access point are active on the network.
	SLS PCS network settings are not configured properly.	Check the SLS PCS IP address and the other network settings.
	If using Ethernet, the network cable is not connected.	Verify that the network cable is connected to the SLS PCS Ethernet port. After reconnecting the cable, disable and then enable the Ethernet connection; refer to “Disabling the Network Connection” on page 4-32.
	If using Wi-Fi, the Wi-Fi adapter is not working.	Verify that the Wi-Fi adapter is inserted in the USB port located at the bottom front right corner of SLS PCS. Switch to Ethernet connection, if available, to see whether a network connection can be established. When correcting the Wi-Fi connection, disable and then enable the network connection to reset it; refer to “Disabling the Network Connection” on page 4-32. Also refer to the “Network/SLS Device Status Problems” section of the troubleshooting table in Chapter 9 of the <i>SLS Administration Tool User’s Manual</i> .
	The SmartDrive has been removed.	Verify that the SmartDrive is connected.

Table 10-2. Troubleshooting (Continued)

Problem	Possible Causes	Solutions
Wi-Fi network connectivity is intermittent or weak, causing SLS PCS to lose its connection to the network.	The distance between SLS PCS and the Wi-Fi router is too far, or there are objects between them that are interfering with the signal.	Add a Wi-Fi repeater to the network that is closer to SLS PCS.

Clearing a Label Media Jam



To clear a label media jam

1. Remove your gloves.
2. Open the front and rear covers.
3. Identify the location of the jammed media and use the appropriate procedure below.

Clearing a Label Jam in the Front Media Guide



To clear a label media jam in the front media guide

1. Gently remove the label media from under the front guide by pulling up the label media near the ink carriage.

CAUTION Avoid peeling up a label in the media path. You might have to pull the media forward through the cutter to avoid peeling a label. If a label is peeled up in the media path, do not press the adhesive side of the label against the sheet metal guides.

2. Use scissors to cut the liner between two labels by the ink carriage to allow you to remove the jammed label media.

NOTE: Scissors are recommended for cutting the liner so that the label media will have a straight edge. The straight edge will make loading the label media easier.

If required, press the **Load** button to advance the label media.

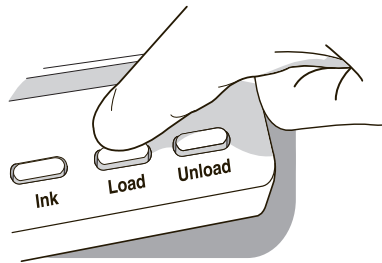

Load button

3. Gently remove the jammed portion of the label media.
4. Review the strip of labels. Make sure that you can account for all of the labels and that no labels are stuck in the front media guide. Discard the damaged label media.
5. If portions of the label media are still jammed in the media path, power off the system (refer to “Powering Off the System” on page 3-45). Use non-metallic tweezers and carefully remove any additional label media from the media path.

6. Press the **Unload** button to reverse any portion of the label media that is still in the media path.

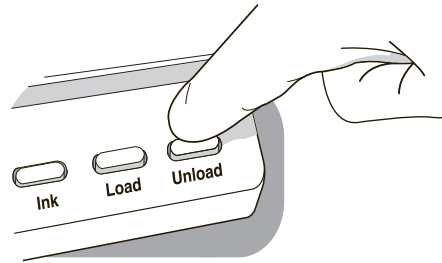

Unload button

7. Inspect the label media. Use scissors to cut off any damaged labels.
8. Close the front cover, load the label media, and close the rear cover.

Clearing a Label Jam in the Rear Media Guide



To clear a label media jam in the rear media guide

1. Identify the location of the jammed media under the rear media guide.
The rear media path can be exposed by using the thumb screws to remove the rear media guide cover.
2. Use scissors to cut the liner between two labels by the ink carriage. This will reduce the number of labels being pulled back through the media path.
3. Gently remove the cut portion of the label media from the front media guide and discard it.
4. Use scissors to cut the liner between the jammed portion of the label media and the label media roll.

NOTE: Scissors are recommended for cutting the liner so that the label media will have a straight edge. The straight edge will make loading the label media easier.

5. Gently remove the jammed portion of the label media.

CAUTION Avoid peeling up a label in the media path. If a label is peeled up in the media path, do not press the adhesive side of the label against the sheet metal guides.

6. Review the strip of labels. Make sure that you can account for all of the labels and that no labels are stuck in the rear media guide. Discard the damaged label media.
7. If portions of the label media are still jammed in the media path, power off the system (refer to “Powering Off the System” on page 3-45). Use non-metallic tweezers and carefully remove any additional label media from the media path.
8. Press the Unload button to reverse any portion of the label media that is still in the media path.

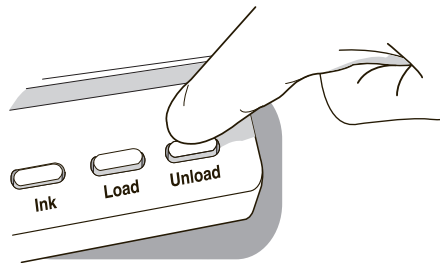

Unload button

9. Inspect the label media. Use scissors to cut off any damaged labels.
10. Close the front cover, load the label media, and close the rear cover.

A

Hazardous Material Information

Materials of Construction

Codonics has set very stringent standards for evaluating products to ensure the marketing of regulatory compliant products worldwide.

We do not intentionally add, nor are we aware, that the products or packaging contain the following materials:

- Mercury, except as used in lamp applications (for example, scanning lamps, backlit LCDs).
- Cadmium, except as used as thick film inks on printed circuit boards.
- Hexavalent Chromium, except as used as thick film inks on printed circuit boards, as chromate conversion coatings on metal surfaces, and as a photoresist on glass panels of cathode ray tubes.
- Polybrominated diphenyl ethers and polybrominated biphenyls.
- Bioavailable arsenic (small amounts of arsenic used in glass, LEDs, and semiconductors are not considered to be bioavailable).
- Bioavailable crystalline silica (small amounts of crystalline silica are used in certain paints, coatings, and filler materials).
- Polychlorinated biphenyls (PCBs).

- Asbestos.
- Organic tin (not used in tin lead solder applications).
- Ozone-depleting substances such as chlorofluorocarbons, methyl chloroform, and carbon tetrachloride.

Matériaux de Construction

Afin d'obtenir les certificats de conformité de ses produits dans le monde entier, Codonics utilise les standards d'évaluation les plus contraignants pour tester ses produits.

Codonics assure notamment n'avoir ajouté ou avoir été informé que soit ajouté les composants suivants dans son produit et son emballage:

- *Mercuré, sauf dans le cas de systèmes d'éclairage (lampe à balayage, rétroéclairage LCD)*
- *Cadmium, à l'exception des encres de couche épaisse sur les circuits imprimés*
- *Chrome hexavalent, à l'exception des encres de couche épaisse sur les circuits imprimés, des protection de surface métallique et des photo résistances de tubes cathodiques*
- *Des éthers de diphényl polybromé ou des biphényls polybromés*
- *Arsenic (de très faible quantité d'arsenic sont présents dans le verre, les leds et les semi-conducteurs sans portée atteinte à l'organisme)*
- *Cristaux de silicium*
- *Biphenyls polychlorés*
- *Amiante*
- *Matières organiques*

- *Substances portant atteinte à la couche d'ozone tels que des carbones chlorofluorés du chloroforme et des tétrachlorures de carbone*

Manufacturing

During manufacturing operations that produce Codonics products (including packaging), no ozone depleting substances (such as chlorofluorocarbons, methyl chloroform, and carbon tetrachloride) are used.

Fabrication

Aucun composant susceptible de détruire la couche d'ozone ne sont utilisés lors de la fabrication (emballage inclus) des produits Codonics.

B

Specifications

Specifications (English)

System:	Integrated capacitive touch screen computer, 2D barcode scanner, color ink jet printer, audio feedback, and provision for a network interface
Ink Cartridges:	One color cartridge (CMY)
SmartDrive:	USB flash drive for storing configuration data, formulary database, log files
Readable Barcodes:	GS1 DataBar Limited (RSS Limited), GS1 DataBar Stacked (RSS-14 Stacked), GS1-128, UPC-A, Data Matrix, Code 128, Code 128 barcodes with GS1-128, Code 39, Code 32, IFT-14, Interleaved 2 of 5, EAN-8, EAN-13
Writable Barcodes:	Data Matrix
Network Interfaces:	Ethernet (RJ-45), included standard Wi-Fi (USB-2 adapter), optional, available from Codonics
Network Speeds:	Ethernet, full duplex 100 Base-T only Wi-Fi, 802.11 b/g/n (2.4 GHz) and 802.11 a/n/ac (5.0 GHz)
Network Protocols:	SSH (Secure Shell) and SCP (Secure Copy) Used to access SLS PCS from Codonics-authorized applications
Dimensions:	Height: 16.5 in. (41.9 cm) Width: 10.43 in. (26.5 cm) Depth: 15.67 in. (39.8 cm)
Weight:	14.5 lbs (6.6 kg)

Power: Universal Input: 100-240 VAC, 50/60 Hz

Intentional Transmitters: When equipped, SLS transmits radio frequency energy at 13.56 MHz using ASK modulation: Effective Radiated Power: -43.14 dBm (48.5 nW).
 When equipped, SLS transmits radio frequency energy within the band of 902–928 MHz using PR-ASK modulation: Peak Effective Radiated Power: 21.94 dBm (156 mW).

Environmental: *Operating:*
 Temperature: 15–30°C (59–86°F)
 Humidity: 20%–80% noncondensing

Shipping and Storage:
 Altitude: Sea Level to 5790 m
 Temperature (Hardware): -22.2–51°C (-8–123.8°F)
 Temperature (Ink Cartridge and Label Media): 1–43°C (34–110°F)
 Humidity (Hardware): 5%–85% noncondensing
 Humidity (Ink Cartridge and Label Media): 5%–80% noncondensing

Medical Compliance and Regulatory: FDA cleared to market per 510(k) K101439 Class II, MDR CE (Class I) 2017/745/EU, GMP/QSR ISO 13485:2016, Safety IEC 60601-1 and EMC IEC 60601-1-2 for Professional Healthcare facilities

Classification: Class II equipment, Product Code BSZ, Regulation Number 868.5160



CAUTION Federal law restricts this device to be sold for use by or on the order of a physician.

Specifications (French)

<i>Système :</i>	<i>Ordinateur à écran tactile capacitif intégré, 2d barcode scanner, imprimante à jet d'encre, feed-back audio, et prestation d'un network interface</i>
<i>Cartouches :</i>	<i>Une cartouche couleur (CMY)</i>
<i>Smart Drive :</i>	<i>USB flash drive pour garder data du configuration, database de formulaire, dossiers du registre</i>
<i>Barcodes livrable :</i>	<i>RSS, UPC-A, B, C, Data Matrix</i>
<i>Barcodes inscriptible :</i>	<i>GS1 DataBar Limited (RSS Limited), GS1 DataBar Stacked (RSS-14 Stacked), GS1-128, Code 128 barcodes with GS1-128, Code 39, Code 32, IFT-14, Interleaved 2 of 5, EAN-8, EAN-13</i>
<i>Interfaces réseau :</i>	<i>Ethernet (RJ-45), inclu en standard Wi-Fi (USB-2 adaptateur), en option, disponible à partir Codonics</i>
<i>Vitesses réseau :</i>	<i>Ethernet, full duplex 100 Base-T seulement Wi-Fi, 802.11 b/g/n (2,4 GHz) et 802.11 a/n/ac (5,0 GHz)</i>
<i>Protocoles réseau :</i>	<i>SSH (Secure Shell) et SCP (Secure Copy) Permet d'accéder SLS PCS d'applications autorisées par Codonics</i>
<i>Dimensions :</i>	<i>Hauteur: 41.9 cm (16.5 in.) Largeur: 26.5 cm (10.43 in.) Profondeur: 39.8 cm (15.67 in.)</i>
<i>Poids :</i>	<i>14.5 lbs (6.6 kg)</i>
<i>Puissance :</i>	<i>Universel Input: 100-240 VAC, 50/60 Hz</i>
<i>Transmetteurs intentionnels :</i>	<i>Lorsqu'il en est équipé, SLS transmet l'énergie radiofréquence à 13,56 MHz en utilisant la modulation ASK. Puissance rayonnée effective : -43,14 dBm (48,5 nW) Lorsqu'il en est équipé, SLS transmet l'énergie des radiofréquences dans la bande de 902 à 928 MHz en utilisant la modulation PR-ASK. Puissance rayonnée efficace maximale : 21,94 dBm (156 mW)</i>

Conditions du travail : *Opération:*
Température: 15–30°C (59–86°F)
Humidité: 20%–80% non condensation

Transport et Stockage:
Altitude: Niveau de la mer to 5790 m
Température (appareil): -22.2–51°C (-8–123.8°F)
Température (les cartouches et les et étiquettes): 1–43°C (34–110°F)
Humidité (appareil): 5%–85% non condensation
Humidité (les cartouches et les et étiquettes): 5%–80% non condensation

Conformité Médical/ Réglementaire : *Conformité Médicale/Réglementaire: Autorisé par la FDA sur le marché selon 510 (k) K101439 Classe II, MDR CE (Classe I) 2017/745/EU, GMP/QSR ISO 13485:2016, Conformité IEC 60601-1 and EMC IEC 60601-1-2 pour les établissements de santé professionnels*

Classification : *Class II équipement, code de produit BSZ, numéro de règlement 868.5160*



CAUTION Conformément à la loi, il est interdit de vendre cet appareil par l'ordre d'un médecin.

Index

A

Accessory Kit box, 2-2
Adjust Label utility, 3-18
Administer Mode, 6-1
associating a Master ID with a Container ID, 5-3, 5-10
audio speaker, 2-6
audio volume, adjusting, 3-37
auto-logout in Batch or Copy Mode, 3-42

B

B.Braun Space Pump, 8-8
barcode scanner, 2-6
 problems, troubleshooting, 10-22
barcodes
 auxiliary, for Container IDs, 5-38
 drug container, troubleshooting problems, 10-15
 verification, 5-3, 5-12
Batch Mode
 auto-logout, 3-42
 end of media, reaching, 5-54
 labels, positioning, 5-48
 labels, printing, 5-47
 labels, printing multiple, 5-48
 screen saver, 3-42

black levels of labels, adjusting, 3-20
Blank labels, 5-41
brightness, adjusting, 3-37

C

cartridges. See ink cartridges.
Clean Nozzles utility, 3-15
cleaning precautions, xxxii to xxxiii, 9-3
cleaning the enclosure, 9-2
Clear Errors utility, 3-30
CN (configuration) label, xxi
Codonics
 email address, xvi
 phone numbers, xvi
 product information, xvi
 website, xvi
Common Login/Common Scan, 8-6
compliance label location, xvii
components shipped, 2-2 to 2-4
concentration, specifying, 5-16
configuration number, xxi
configuration settings, 2-31
configuration update package
 installing manually, 9-6
 installing remotely, 9-8

- configuration version, 10-7
- container barcodes
 - problems, troubleshooting, 10-15
 - verification, 5-3, 5-12
- Container ID, 5-2
 - associating with a Master ID, 5-3, 5-10
 - auxiliary barcodes, 5-38
 - mapping to Master IDs, 5-3, 5-10
 - multiple matches, 5-2, 5-9
- Container IDs
 - non-compliant, printing a placeholder, 5-39
- Copy Mode
 - auto-logout, 3-42
 - end of media, reaching, 5-54
 - labels, printing, 5-56
 - screen saver, 3-42
- cover, removing rear, 9-12
- custom labels, 5-40 to 5-46
 - categories, 5-40
 - printing, 5-45

D

- Dark Print setting, 3-20
- Dashboard, 10-1
- database
 - formulary, 2-31, 5-1
 - tracking, 2-32
 - user, 2-31
- date and time, setting, 3-35
- date code, xxi
- Date/Time prompt, 2-19
- device characteristics, xxxvii
- device description, xxxvii
- device indications for use statement, xxxix
- DHCP acquisition method, 4-6, 4-9, 4-13, 4-21, 4-24
- diluent
 - specifying with Normal Dilution, 5-16

- specifying with TD/TV, 5-19
- Dilute switch, 3-11, 5-7, 5-16
- dilution
 - specifying, 5-16
- disinfecting precautions, xxxiii to xxxiv, 9-4
- disinfecting the enclosure, 9-4
- disposal requirements, xxxv
- drug container barcodes
 - problems, troubleshooting, 10-15
 - verification, 5-3, 5-12
- Drug Not Found events
 - communication to SLS Administration Tool, 5-3
 - when they occur, 5-13
- drug preparation methods, 5-4
- drug records, verification, 5-3, 5-12

E

- electromagnetic emissions
 - guidance, xxiv
 - standards, xxvi
 - test levels, xxvi
- electromagnetic immunity
 - guidance, xxiv
 - standards, xxvi
 - test levels, xxvi
- Enterprise Wi-Fi
 - configuring network connection, 4-9
 - disabling the network connection, 4-32
 - network connection status, 4-35
 - selecting network, 4-15
 - selecting security type, 4-18
 - when network connection settings are saved, 4-37
- errors, clearing, 3-30
- Ethernet
 - configuring network connection, 4-3
 - connecting cable, 2-13
 - disabling the network connection, 4-32

- displaying IP address, 10-6
- MAC address, 2-11, 10-6
- network connection status, 4-35
- SLS port, 2-9
- when network connection settings are saved, 4-37

European disposal requirements, xxxv

external power supply

- connecting, 2-13, 2-15, 2-16
- ordering, 9-1

F

fast print mode, setting, 3-22

feature keys, 3-32

features, adding, 3-32

formulary

- database, 2-31, 5-1
- problems, troubleshooting, 10-13
- version, 10-7

formulary update package

- installing manually, 9-6
- installing remotely, 9-8

front cover, 2-6

H

hazardous material information, A-1 to A-3

I

inactivity logout, 3-41

inactivity touch screen blanking, 3-42

indications for use, xxxvii

information, displaying, 10-2

Ink button, 2-7

ink cartridge

- cleaning nozzles, 3-15
- installing, xiii, 2-21
- ordering, 9-1
- problems, troubleshooting, 10-21

ink cartridge carriage, 2-8

IP acquisition method, 4-6, 4-9, 4-13, 4-21, 4-24

IV labels, 5-43

L

label cutter, 2-8

label media

- Batch Mode, reaching end of media, 5-54
- clearing jam, 10-24
- Copy Mode, reaching end of media, 5-54
- hubs, 2-27
- loading, 2-27
- ordering, 9-1
- replacing, 2-27
- roll behavior, 2-30
- Unload button, 9-14

label media guides, 2-28

label type buttons, 3-11

labels

- Batch Mode, positioning for, 5-48
- Batch Mode, printing in, 5-47
- Batch Mode, printing multiple, 5-48
- black levels, adjusting, 3-20
- Blank, 5-41
- confirming syringe labels after printing, 5-36, 5-40
- confirming syringe labels before printing, 5-34
- Copy Mode, printing in, 5-56
- custom, 5-40 to 5-46
- custom, printing, 5-45
- EBD-1, 7-13
- EHR-1, EHR-2, 7-13
- invalid patient information, how handled, 8-13

- IV, 5-43
- JP-S1, JP-1 Japan, 7-12
- label template packs, 7-1
- Lines, 5-42
- ME-S1, ME-1 Middle East and Australian, 7-10
- Patient, 5-44
- patient information, printing on, 8-9
- patient information, supported, 8-12
- printing problems, troubleshooting, 10-18
- printing syringe labels, 5-6
- RBX-1, over-labeling, 7-9
- sizes, 7-1
- STD-1, 7-2
- STD-2, 7-3
- STD-3, 7-4
- template properties, 7-6
- user initials and IDs in, 7-8
- ZH-S1, ZH-1 China, 7-11
- learning, 5-3, 5-10
- LED status indicators, 10-1
 - system status, 3-11
- License Code, 2-31
- Lines labels, 5-42
- Load button, 2-7
- location for the device, 2-1
- location precautions, xxx to xxxi
- log files, 2-32
 - backing up, 3-27
- logging in, 3-3
- logging out, 3-40
- Logout button, 3-11

M

- MAC address
 - Ethernet, 2-11
 - Wi-Fi, 2-11
- Manage Features utility, 3-32

- mapping, 5-3, 5-10
- Master ID, 5-2
 - associating with a Container ID, 5-3, 5-10
 - mapping to Container ID, 5-3, 5-10
- media
 - clearing jam, 10-24
 - reaching end of, Batch and Copy Modes, 5-54
 - roll behavior, 2-30
- media guides, 2-28
- media path, adjusting, 3-18
- media precautions, xxxiv
- modification codes, xxi
- Muted volume icon, 3-38, 10-1

N

- network
 - configuring connection, overview, 4-1
 - configuring Enterprise Wi-Fi connection, 4-9
 - configuring Ethernet connection, 4-3
 - configuring non-Enterprise Wi-Fi connection, 4-21
 - connection status, 4-35
 - disabling the connection, 4-32
 - information about, 10-6
 - problems, troubleshooting, 10-23
 - remote system information, 10-6
 - setting up network hardware, 4-3
 - static device names, 4-2
 - when connection settings are saved, 4-37
- Network utility, 3-26, 4-4, 4-10, 4-33
- non-compliant Container IDs, printing a placeholder graphic, 5-39
- Normal Dilution
 - drug preparation method, 5-4
 - specifying the dilution and diluent, 5-16

O

Other Item events
 when they occur, 5-13
output bin, 2-6

P

parts, ordering, 9-1
patient case, starting, 8-11
patient information
 invalid, how handled, 8-13
 labels that support, 8-12
 printing on labels, 8-9
Patient labels, 5-44
PIN, user, 3-2
 entering, 3-6
Plexus TG Anesthesia Touch, 8-7
power cord, ordering, 9-1
power input port, 2-9
Power LED
 front cover, 2-6
 touchscreen, 2-12
power supply
 connecting, 2-13, 2-15, 2-16
 ordering, 9-1
Power switch, 2-9
power, applying, 2-13, 2-15, 2-16
powering off the system, 3-45
precautions
 cleaning, xxxii to xxxiii, 9-3
 disinfecting, xxxiii to xxxiv, 9-4
 location, xxx to xxxi
 media, xxxiv
 safety, xxviii to xxix
prescription for use device, xxxix
printer

 calibrating, 3-25
 firmware version, 10-7
 information about, 10-4
printing custom labels, 5-45
purpose of User's Manual, xv

R

radio frequency energy, potential operator exposure, xxiii
radio frequency interference, xxii
rear cover, 2-6
 removing, 9-12
remote system information for a network, 10-6
Reset button, touch screen, 2-12
restart, 3-43

S

Safe Label System
 applying power, 2-13, 2-15, 2-16
 cleaning, 9-2
 cleaning precautions, xxxii to xxxiii, 9-3
 components inside front cover, 2-7
 components, front, 2-5
 components, rear, 2-9, 2-11
 components, touch screen, 2-12
 configuration number, xxi
 configuration settings, 2-31
 configuration version, 10-7
 date code, xxi
 device characteristics, xxxvii
 device description, xxxvii
 device indications for use statement, xxxix
 disinfecting, 9-4
 disinfecting precautions, xxxiii to xxxiv, 9-4
 disposal requirements, xxxv

- formulary version, 10-7
 - hazardous material information, A-1 to A-3
 - indications for use, xxxvii
 - information about, displaying, 10-2
 - License Code, 2-31
 - location precautions, xxx to xxxi
 - location, finding, 2-1
 - log files, 2-32
 - log files, backing up, 3-27
 - media precautions, xxxiv
 - modification codes, xxi
 - parts, ordering, 9-1
 - powering off, 3-45
 - printer firmware version, 10-7
 - product features, 1-2 to 1-3
 - radio frequency interference, xxii
 - restart, 3-43
 - safety and compliance label locations, xvii
 - safety precautions, xxviii to xxix
 - serial number, 10-7
 - serial number label, xxi
 - shipped components, 2-2 to 2-4
 - shipping, preparing for, 9-13
 - shutdown, 3-43
 - software version, 10-7
 - specifications, B-1 to B-4
 - starting up, 2-19
 - status indicators, 10-1
 - supplies, ordering, 9-1
 - swapping, 9-13
 - system status, 3-11
 - television frequency interference, xxii
 - troubleshooting, 10-10 to 10-24
 - utilities, 3-12
 - voltage warning, xviii
 - website, xvi
- safety
- location of labels, xvii
 - precautions, xxviii to xxix
- scanner problems, troubleshooting, 10-22
 - scanner, wired hand, 8-1
 - cleaning and disinfecting, 8-4
 - configuring, 8-4
 - connecting, 8-2
 - testing, 8-3
 - screen saver in Batch or Copy Mode, 3-42
 - serial number label, xxi
 - serial number of system, 10-7
 - shipping the device, preparing for, 9-13
 - shutdown, 3-43
 - single cut printing, 5-55
 - SLS Advanced Smart Scanning (SASS), 5-61
 - use cases, 5-61
 - SLS. See Safe Label System.
 - SmartDrive
 - information stored on, 2-31
 - inserting, 2-18
 - overview, 2-31
 - software version, 10-7
 - specifications, B-1 to B-4
 - starting up the system, 2-19
 - Static acquisition method, 4-6, 4-9, 4-13, 4-21, 4-24
 - status indicators, 10-1
 - status messages, 10-1, 10-8
 - status, information about, 10-3
 - strip cut printing, 5-54
 - supplies, ordering, 9-1
 - syringe labels
 - confirmation problems, troubleshooting, 10-15
 - confirming after printing, 5-36, 5-40
 - confirming before printing, 5-34
 - printing, 5-6
 - System Information button, 3-11, 10-2
 - System Information window, 10-2
 - Network tab, 10-6
 - Printer tab, 10-4
 - Status tab, 10-3
 - System tab, 10-7

- User tab, 10-5
- system information, displaying, 10-2
- system log files, 2-32
 - backing up, 3-27
- system problems, troubleshooting, 10-10
- system serial number, 10-7
- system software
 - installing manually, 9-9
 - version, 10-7
- system status messages, 10-8
- system, information about, 10-7

T

- television frequency interference, xxii
- test label
 - printing, 3-7
 - verifying, 3-8
- Test/Review mode, 9-6
- Total Dose/Total Volume (TD/TV)
 - drug preparation method, 5-4, 5-5
 - specifying, 5-19
- touch screen, 2-6
 - blanking due to system inactivity, 3-42
 - brightness, adjusting, 3-37
 - components, 2-12
 - main screen elements, 3-11
 - problems, troubleshooting, 10-13
 - rear panel door, 2-18, 9-11
 - USB port, 2-6, 9-7
- tracking database, 2-32
- troubleshooting, 10-10 to 10-24
 - barcode scanner problems, 10-22
 - drug container barcode problems, 10-15
 - formulary problems, 10-13
 - ink cartridge problems, 10-21
 - label printing problems, 10-18
 - network, 10-23

- syringe label confirmation problems, 10-15
- system problems, 10-10
- touch screen problems, 10-13

U

- Unload button, 2-8, 9-14
- update package
 - installing manually, 9-6
 - installing remotely, 9-8
- USB port
 - behind rear panel door, 2-9, 2-11
 - rear panel door, 2-18, 9-11
 - touch screen, 2-6, 2-12, 9-7
- USB port for Wi-Fi adapter, 2-10
- user
 - information about, 10-5
 - logging in, 3-3
- user badge
 - making, 3-1
 - printing, 3-23
 - scanning barcode, 3-3
- user database, 2-31
- User's Manual, purpose, xv
- utilities, 3-12
 - Adjust Label, 3-18
 - Clean Nozzles, 3-15
 - Clear Errors, 3-30
 - closing the Utilities screen, 3-39
 - Dark Print setting, 3-20
 - displaying Utilities screen, 3-14
 - Manage Features, 3-32
- Utilities button, 3-11

V

- verification, 5-3, 5-12
 - events, communication to SLS Administration Tool, 5-3
- voltage warning, xviii
- volume
 - adjusting, 3-37
 - Muted icon, 3-38, 10-1

W

- WEEE (Waste Electrical and Electronic Equipment) disposal directive, xxxvi
- Wi-Fi
 - adapter USB port, 2-10
 - adapter, connecting, 2-15
 - configuring Enterprise network connection, 4-9
 - configuring non-Enterprise network connection, 4-21
 - disabling the network connection, 4-32
 - displaying IP address, 10-6
 - MAC address, 2-11, 10-6
 - network connection status, 4-35
 - selecting network, 4-15, 4-26
 - selecting security type, 4-18, 4-28
 - signal strength, 10-6
 - WAP and WAP2 security, 4-29
 - WEP security, 4-29
 - when network connection settings are saved, 4-37
- wired hand scanner, 8-1
 - cleaning and disinfecting, 8-4
 - configuring, 8-4
 - connecting, 8-2
 - testing, 8-3
- wiring for future RFID capability, 2-8